

20
24



HIGHLAND
ENGINEERED QUALITY



SEADIVE OCEANways

Faber

THUNDERBIRD
CYLINDERS

THERMO

miflex hoses

REGULATORS

06

Breathe easy. We've got you covered with an assortment of regulators, octopuses, breathable inflators, hookah and more.

BUOYANCY COMPENSATORS

17

From jackets and back inflation, to backplates and wings, you'll be buoyed for success!

GAUGES

32

We offer a wide assortment of pressure, depth, and compass instruments.

HOSES

42

Braided, technical and rubber hoses are available in multiple lengths.

CYLINDERS

54

See the wide assortment of sizes, colors, and finishes.

VALVES

60

The most trusted, best-selling valves in the industry!

CYLINDER ACCESSORIES

68

Don't let that cylinder go out the door naked. Accessorize it!

BAGS

76

Peruse our collection of built-for-purpose dive bags.

MASKS

85

You can clearly see that we offer one of the widest assortments of masks in the industry.

SEADIVE

94

Coated lens masks with names like RayBlocker®-HD, TrueColor™ & Hydrophobic™

OCEANWAYS

100

Masks that are enhancing the dive experiences around the globe.



Used with permission by info@divethecave.com

SNORKELS

107

Dry tops, semi-dry tops and traditional open tops mean that there is a snorkel for every age and skill level.

FINS

112

You'll get a kick out of our fin assortment. Long, short, rubber or plastic, we have a fin to fit your needs.

NEOPRENE

118

- Boots	118	- Rash Guards	128	- Socks	120	- Shorts	128
- Gloves	121	- Pockets	129	- Wetsuits	124	- Hoods	130

HANGERS

132

Whether they're protecting a wetsuit or drying a pair of booties, hangers are often overlooked, but oh so important!

KNIVES

134

Traditional blades or scissor knives, our assortment is a cut above the competition.

LIGHTS

138

Lights, camera, action! Three elements needed for a great scuba dive!

ACCESSORIES

142

- UFO	142	- Retractors	146
- Coils	148	- Rattlers	149
- Freediving Lanyard	149	- Mouthpieces	150
- Diver's Multi Tools	151	- Slates	154
- Spools & Reels	155	- Tech Pockets	158

LIFT BAGS / SMB'S

159

With names like Smart Marker and Quick Launch, our expanding assortment of lift bags and SMBs are setting the standard for safety and functionality.

WEIGHTS

163

Here you'll find coated, uncoated, shot mesh, ankle, quick attach, belts, buckles, pockets and more.

HARDWARE

171

Double-enders, shackles, bolt snaps, split rings and more, we have more hardware than Inspector Gadget.

TOOLS

175

We offer a fine assortment of scuba tools for divers as well as repair technicians.

SIZE CHARTS

186



XPLORE REGULATOR

The Xplore regulator combines performance, reliability and economy in one package. Designed to take the high-use demands of a rental department without the need for constant adjusting. Factory cleaned and ready for pre-blended Nitrox up to 40% oxygen.

09



benthic COMPRESSION SHORTS

Maintain your modesty without fighting the ride-up that traditional swim trunks cause. Benthic Compression Shorts are the perfect wetsuit undergarment.

129



QUIKVU INSTRUMENTATION

XS Scuba is pleased to offer a new lineup of analog instrumentation for 2024!

The compact, lightweight consoles have integrated attachment points on both sides for multiple configuration options. The thin, braided HP hoses are lighter weight and more flexible than their rubber counterparts.



32

APTOS An entry-level freediving fin with an extremely comfortable rubber footpocket and an interchangeable, polypropylene blade.



112

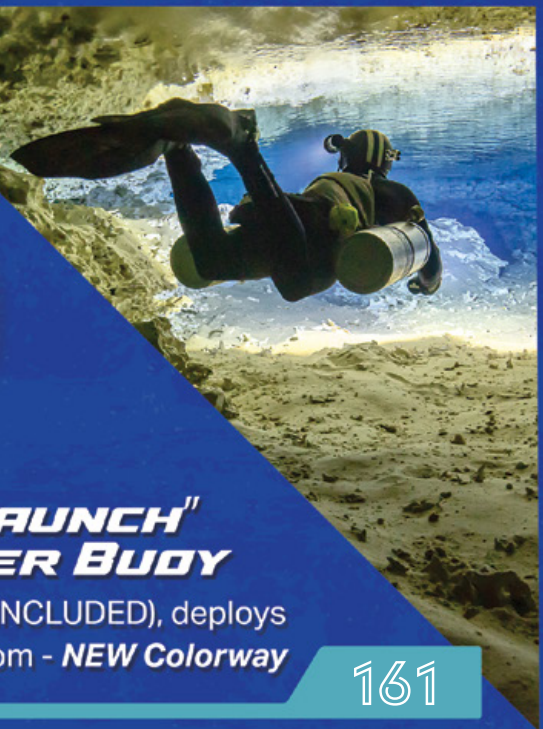

"QUICK LAUNCH" MARKER BUOY

Pre-attached spool (INCLUDED), deploys out the bottom - **NEW Colorway**

161

HIGHLAND

ENGINEERED QUALITY



DARK WATER

Head to where the adventure is. Head to the Dark Water.

This frameless mask features pure, ultra-clear glass, which eliminates the green tint found in normal mask glass.

OUTER LIMITS

Let your next expedition lead you to the Outer Limits.

The universal fit, coupled with the HD time-proven buckles, makes this the choice of serious divers.



SQUALL POCKET

The Squall Pocket is perfect for carrying your backup mask. The semi-rigid sides allow the mask to slide right in.

85

EVERYTHING FOR THE PERFECT DIVE



Vortex Regulator

The Vortex is a technical diving regulator that lends itself well to cold, deep, and extended range diving. It configures nicely with sidemount and twin cylinder systems. The outstanding performance is a requirement for the Vortex to be branded Highland.

- Suitable for cold water use in water temperatures below 50°F / 10°C
- Compatible with EAN40 right out of the box
- Available with DIN or yoke connection
- Comes with a custom designed Miflex braided hose. Miflex hoses are lightweight and extremely flexible

1st Stage:

- A 5th port located on the end of a swivel turret allows for optimum hose configuration for sidemount or twin cylinder setups
- An external, secondary diaphragm keeps water out of the main spring chamber preventing ice buildup
- Heat exchanger ribs, integrated into the main body, provide added thermal protection, minimizing the chance of freeze-up
- Two high-pressure ports allow for use of a computer transmitter along with an analog back-up gauge
- A black chrome finish, with a high quality PVD coating on the heat exchanger, means that the Vortex regulator is durable and prepared for all environments

2nd Stage:

- Pneumatically balanced for superior breathing performance
- An adjustment control knob allows the diver to dial in the inhalation resistance
- An integrated venturi lever allows the diver to shut down the venturi assist when the regulator is out of the mouth
- A Comfy-bite mouthpiece, with palate bridge, eliminates jaw fatigue
- A heat exchanger warms the second stage valve providing effective freeze resistance
- The purge button has a limited throw, minimizing the chance of a freeze-up
- This second stage is fully reversible left/right using the conversion kit (see below)
- Technicians will enjoy the convenient micro-adjuster located within the adjustment knob



Part #	Description	Retail
RGH600	Highland Vortex Regulator - Yoke	660.00
RGH610	Highland Vortex Regulator - DIN	
RPH600	Complete DIN Adapter - Vortex	105.00
HL435	Highland Spin-On Yoke	60.00
RPH650	Left / Right Conversion Kit	10.00
RKH01Y	Service Kit-Vortex 1st Stage - Yoke	36.00
RKH01D	Service Kit-Vortex 1st Stage - DIN	
RKH02	Service Kit - Vortex Second Stage	14.00



Vortex Octopus

- Pneumatically balanced for superior breathing performance. Your buddy will appreciate that your Vortex Octopus will equal the performance of your Vortex primary second stage
- An adjustment control knob allows the diver to dial in the inhalation resistance
- An integrated venturi lever allows the diver to shut down the venturi assist when the regulator is out of the mouth
- A heat exchanger warms the internal valve providing effective freeze resistance
- The purge button has a limited throw, minimizing the chance of a freeze-up
- This second stage is fully reversible left/right using the conversion kit (see below)
- The custom 40 in (102 cm) Miflex hose is lightweight and pliable



Part #	Description	Retail
RGH650	Octopus - Vortex	245.00
RPH650	Left / Right Conversion Kit	10.00



Used with permission by info@divethecave.com

HIGHLAND ENGINEERED QUALITY Vortex Regulator Streamlined Set

An alternate way for a sport diver to configure their regulator instead of using a yellow octopus at the end of a long, yellow hose. The streamlined set prevents hoses from dangling and optimizes comfort.

In the streamlined configuration, the hose on the primary regulator routes under the diver's arm and attaches to the second stage with a 90° swivel adapter, optimizing comfort because the hose is no longer tugging on your mouth. The backup regulator, inserted into a regulator necklace, is tucked safely under the chin, allowing immediate access. In an emergency, the primary is donated while the backup is instantly available. The SPG is clipped to the waist D-ring using the snap.

- Vortex DIN First Stage (p/n RGH610-01)
- Two Vortex Second Stages (p/n RGH600-02)
- 40 in (102 cm) Miflex LP Hose - Black (p/n MLP40-BK)
- 22 in (56 cm) Miflex LP Hose - Black (p/n MLP22-BK)
- Vortex Spin-On Yoke - Black (p/n AC370BK)
- Highland Bungee Regulator Necklace (p/n HL615)
- 90° Right Angle Adapter (p/n AC910)
- Highland 2 in (5 cm) Brass and Glass SPG w/ PVD finish - Dual Scale (p/n HL301-DS-PVD)
- 24 in (61 cm) Miflex HP Carbon Hose (p/n MHP24-CN)
- Highland 4.0" "U-Top" Swivel Bolt Snap (p/n HL913)
- 22 in (56 cm) Miflex QD Hose (p/n MQD22-BK)



Part #	Description	Retail
RGH620	Highland Vortex Regulator Streamlined Set	995.00



Used with permission by info@divethecave.com

Inspire Regulator

The Inspire is a performance regulator that provides superior breathing. It breathes quietly, smoothly and breathes dry in all positions. It proves that you do not have to pay top dollar to get performance and features. Factory cleaned and ready for pre-blended Nitrox up to 40% oxygen. The Inspire is for use in water >50° F (10° C).

- Compatible with EAN40 right out of the box
- Available with DIN or yoke connection
- Comes with a custom designed Miflex braided hose. Miflex hoses are lightweight and extremely flexible

First Stage:

- Balanced diaphragm first stage
- Two high-pressure ports allow for use of a computer transmitter along with an analog back-up gauge
- 4 MP ports built into a rotating turret for optimum hose routing

Second Stage:

- Pneumatically balanced for superior breathing performance
- An adjustment control knob allows the diver to dial in the inhalation resistance
- An integrated venturi lever allows the diver to shut down the venturi assist when the regulator is out of the mouth
- A Comfy-bite mouthpiece, with palate bridge, eliminates jaw fatigue
- Technicians will enjoy the convenient micro-adjuster located within the adjustment knob



Part #	Description	Retail
RG500	Inspire Regulator - Yoke	530.00
RG510	Inspire Regulator - DIN	
RP510	DIN Connector - Complete	70.00
RK13	Inspire First Stage Service Kit	30.00
RK12	Brawn/Inspire Second Stage Service Kit	17.00

Inspire Octopus

- High visibility front cover and hose
- Offers the same high performance as the Inspire primary second stage
- An Inhalation Control Knob to adjust breathing effort
- A venturi lever allows the diver to turn off the venturi boost when the regulator is out of the mouth
- The 40 in (102 cm) custom Miflex hose is lightweight and pliable



Part #	Description	Retail
RG550	Inspire Octopus	200.00
RK12	Brawn/Inspire Second Stage Service Kit	17.00



Xplore Regulator

The Xplore regulator combines performance, reliability and economy in one package. Designed to take the high-use demands of a rental department without the need for constant adjusting. Factory cleaned and ready for pre-blended Nitrox up to 40% oxygen.

First Stage:

- Lightweight and compact
- In-line piston design
- Rental tough
- 4 MP ports
- 1 HP port

Second Stage:

- Pneumatically balanced downstream design
- Adjustable dive/pre-dive venturi lever
- Flexible, easy purge cover for quick clearing
- Chambered exhaust tee directs bubbles away from your face



Xplore Octopus

- Hi-viz yellow front cover and hose allows for easy identification in an emergency
- Pneumatically-balanced to provide superior breathing performance
- An integrated venturi lever allows the diver to turn off the venturi when the regulator is out of the mouth. This prevents unwanted free-flow
- The 40 in (102 cm) yellow hose provides extra length for your buddy



Part #	Description	Retail
RG460	Xplore Regulator	365.00
RG465	Xplore Octopus	170.00
RP460	DIN Connector - Complete	58.00



MultiMax



MultiMax
*Multiple Functions
 Maximum Performance*

MultiMax Breathable Inflator

The MultiMax adds convenience, efficiency and safety to your dive. By combining an alternate air source with an inflator, there is one less hose coming off the first stage. Gone are the days where the octopus is dragging in the sand or across fragile coral. The breathable MultiMax is located where your BC inflator resides. This makes it easy to find since you operate your inflator many times throughout each dive. In an out-of-air situation, your hand knows right where to go.

- Large, color differentiated buttons are easy-to-use, even with thick gloves
- The soft-touch purge cover is located on the bottom of the unit so it will not be affected by strong currents
- Easy-connect, push-on hose connector is very glove friendly
- Downstream demand valve with venturi assist for performance and reliability
- Custom 26 in (66 cm) Miflex regulator hose allows maximum flow to the MultiMax
- Includes inlet protective cap to keep out water and particulates
- The MultiMax has successfully passed the certification tests required by EN250:2014 to an auxiliary emergency breathing device integrated with a buoyancy inflation system
- Available with either 3/4" or 1" hose connection



Part #	Description	Retail
RG370	MultiMax Breathable Inflator with 3/4" Connection	245.00
RG371	MultiMax Breathable Inflator with 1" Connection	245.00
RG375	MultiMax - Installed On New XS Scuba BC	-
RK14	Service Kit	15.00

Standard Octopus

The Standard Octopus is designed for the diver who wants the reliability of knowing they have a safe second in an emergency, but doesn't want to spend a fortune on a piece of equipment that they hope never to use. This octopus is a favorite of rental applications because of its simplicity of design.

Features:

- Designed to provide reliable breathing performance
- Simplicity of design is perfect for rental applications
- Large diaphragm for quick inhalation response
- Large exhaust valve decreases exhalation effort
- Yellow color is easy to find in an emergency
- Adjustable dive/pre-dive switch
- 40 in (102 cm) yellow rubber hose



Part #	Description	Retail
RG360	Standard Octopus	100.00
RK9	Standard Octopus / Hookah Service Kit	16.00

AltAir Octopus

The AltAir utilizes the same patented quick-release buckles used on today's modern weight integrated BC's. Just grab and pull the AltAir, that's all that is needed to release the patented X-Lock™ buckle.

Features:

- Exclusive X-Lock™ attachment
- Intelligent, inline mouthpiece orientation
- Reliable, free-flow resistant design
- Choose 36 in (91 cm) yellow Miflex or 36 in (91 cm) black rubber hose



Part #	Description	Retail
RG300BK	AltAir Octopus - Black Rubber Hose	110.00
RG300YL	AltAir Octopus - Yellow Miflex Hose	132.00
RP300AH	AltAir Accessory Clip - Replacement	6.00
RK4	AltAir Service Kit	16.00

Hookah Regulator *(LP Hose Not Included)*

The term "hookah" refers to the breathing gas being supplied from the surface

- **RG303** - uses an intermediate pressure of 50–80 psi (3.5–5.5 bar)
Often used with compact specialty compressors
- **RG305** - uses an intermediate pressure of 80–110 psi (5.5–7.5 bar)
Often used with larger, commercial grade, specialty compressors
- **RG310** - uses an intermediate pressure of 110–140 psi (7.5–9.5 bar)
Typically used with scuba cylinders left on the surface with a long hose
- A robust, over-built design for commercial-style use
- Venturi deflector to prevent accidental free-flows
- Simple and easy to service

Choose From:

- 50 to 80 PSI
- 80 to 110 PSI
- 110 to 140 PSI

HOOKAH LENGTH REGULATOR HOSES

See Page 47



Rubber & Miflex



Part #	Description	PSI	Retail
RG303	Hookah Second Stage	50-80 PSI	110.00
RG305		80-110 PSI	
RG310		110-140 PSI	
RK9	Standard Octopus / Hookah Service Kit		16.00

XTR Extra Air Complete Backup Rescue System

Highland Mini Tech Gauge (HL502)
0 to 5000 psi, wide 210 degree sweep
Chromed brass case w/ rubber boot

Highland Compact First Stage (HL406)
Highland DIN direct inlet
Simple flow-by piston design



XS Scuba PRO Valve (VX200-30N-VI)
Combination DIN/Yoke outlet
DIN insert included

DIN Cap (HL401)
Seal water out of your first stage
Machined Delrin material

Highland Pony Mount (HL409 or HL412)
Highland design
Stainless steel construction
Quick & easy attachment
Secure under your current BC strap

Cylinder Choices:
Aluminum 6 cu ft - neon yellow
Aluminum 13 cu ft - neon yellow (pictured)
Aluminum 19 cu ft - neon yellow



Primary Cylinder & Tank Cam Strap Not Included

AltAir (RG300)
Compact, low profile octopus
Easy, high flow purge
Built-in attachment clip for BC

90° Right Angle Adapter (AC910)
Chromed brass construction

Miflex Hose (MLP40-MY)
Low pressure regulator hose
Length: 40 in (102 cm)
Color: yellow

Part #	Description	Retail
XTR-06	Extra Air - Aluminum 6 cu ft	525.00
XTR-13	Extra Air - Aluminum 13 cu ft	575.00
XTR-19	Extra Air - Aluminum 19 cu ft	599.00

Pony Reg Complete Pony Regulator System

- Compact, DIN 1st stage uses flow-by piston design
- One HP and 2 MP ports
- Mini Tech Gauge is made of brass (0 to 5000 psi)
- Miflex yellow hose is 40 in (102 cm) long
- Compact, low profile AltAir features single pull release X-Lock™ buckle



Optional Spin-On Yoke p/n AC370

For use with K valve

XS Scuba 90° Right Angle Adapter (AC910)

Highland Compact
DIN First Stage (HL406)

Highland DIN Cap
Machined Delrin (HL401)

XS Scuba AltAir Octopus with
built-in attachment clip (RG300)

Highland Mini Tech Gauge
with rubber boot (HL502)

Miflex 40 in (102 cm) Low Pressure Hose Yellow (MLP40-MY)

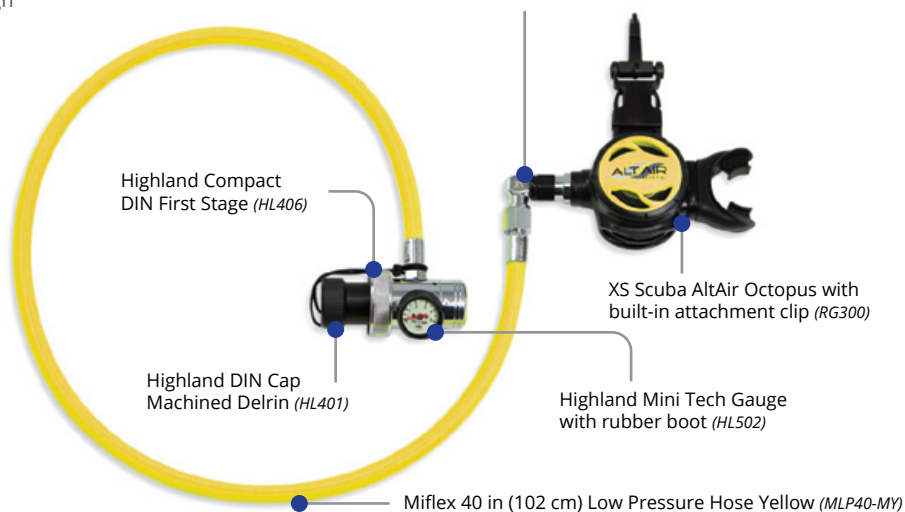

Part #	Description	Retail
RG350	Pony Regulator System	280.00
AC370	Standard Spin-On Yoke	50.00
RP300AH	AltAir Accessory Clip - Replacement	6.00
RK8	Service Kit / Compact DIN 1st Stage	23.00
RK4	AltAir Service Kit	16.00



HIGHLAND ENGINEERED QUALITY Compact Argon Regulator

- Compact, low profile first stage
- Specifically designed for drysuit inflation
- Flow-by piston design
- One HP and two MP ports
- Factory set I.P. at 115 to 125 psi at 3000 psi
- Direct attachment to 200 or 300 bar DIN connection
- Includes 22 in (56 cm) orange Miflex QD Hose
- Includes Over Pressure Valve (p/n AC395)
- Includes Delrin DIN cap w/ lanyard (p/n HL401)
- Includes Mini Tech Gauge with rubber boot (p/n HL502)
- Optional Spin-On Yoke for yoke attachment (p/n AC370BK)



Part #	Description	Retail
HL405	Compact Argon Regulator with Gauge (psi)	220.00
HL405M	Compact Argon Regulator with Gauge (bar)	
RK8	Service Kit / Compact DIN 1st Stage	23.00
AC370BK	Standard Spin-On Yoke - Black	60.00

HIGHLAND ENGINEERED QUALITY Compact DIN First Stage

- Compact, low profile first stage
- Flow-by piston design
- One HP and two MP ports
- Factory set I.P. at 135 to 145 psi at 3000 psi
- Direct attachment to 200 or 300 bar DIN connection
- Includes Delrin DIN Cap (p/n HL401)
- Clean for Nitrox up to 40% O₂
- Optional Spin-On Yoke for yoke attachment (p/n AC370)



Part #	Description	Retail
HL406	Compact DIN First Stage	120.00
RK8	Service Kit / Compact DIN 1st Stage	23.00
AC370	Standard Spin-On Yoke	50.00

HIGHLAND ENGINEERED QUALITY Delrin DIN Cap

- Precision machined from Delrin
- Protects threads on DIN first stage
- Seals water out of first stage
- Fits all 200 bar and 300 bar DIN



Part #	Description	Retail
HL401	Delrin DIN Cap	22.00



Deluxe Inline Shut-Off

- Install between standard regulator hose and second stage
- Slide collar shuts off gas flow
- Commonly used with deco rigs, stage bottles & drysuit inflation
- Prevent critical gas loss
- 9/16"-18 UNF male inlet to 9/16"-18 UNF female outlet threads
- Low pressure use only - below 200 psi

WARNING: When shutting off gas supply to the second stage, there must be some other type of over-pressure relief device present.

Open



Closed



Part #	Description	Retail
HL404-DLX	Deluxe Inline Shut-Off (for Second Stage)	66.00
HK404-DLX	Service Kit for HL404-38 and HL404	8.00



Inline Shut-Off For First and Second Stage

Inline Shut-Off for First Stage

- Install between first stage MP port and standard regulator hose
- Slide collar to shut off gas flow
- Commonly used with rebreather systems
- 3/8"-24 UNF male inlet to 3/8"-24 UNF female outlet threads
- Low pressure use only - below 200 psi

WARNING: When shutting off gas supply to the second stage, there must be some other type of over-pressure relief device present.

Inline Shut-Off for Second Stage

- Install between standard regulator hose and second stage
- Slide collar to shut off gas flow
- Commonly used with deco rigs, stage bottles & drysuit inflation
- 9/16"-18 UNF male inlet to 9/16"-18 UNF female outlet threads
- Low pressure use only - below 200 psi

HL404-38



HL404



Part #	Description	Retail
HL404-38	Inline Shut-Off (for First Stage)	48.00
HL404	Inline Shut-Off (for Second Stage)	
HK404	Service Kit for HL404-38 and HL404	8.00



Bungee Necklace

Sure, you can buy bungee and make your own, but you don't need to! We've made it too convenient.

- Use this bungee necklace for your backup, short-hose regulator
- The circumference is fully adjustable
- Quality, 4 mm thick bungee



Part #	Description	Retail
HL615	Bungee Necklace	4.00



Silicone Regulator Necklace

- Attaches easily to any regulator second stage mouthpiece
- Allows regulator to hang close under the chin
- Keep your second stage where you need it
- Durable, "no memory" silicone
- Standard: 7.5 in (191 mm) diameter
- Large: 10 in (254 mm) diameter



Part #	Description	Color	Diameter	Retail
HL601BK	Standard Regulator Necklace	Black	7.5"	14.00
HL601BK-LG	Large Regulator Necklace		10"	16.00
HL601YL	Standard Regulator Necklace	Yellow	7.5"	14.00
HL601YL-LG	Large Regulator Necklace		10"	16.00

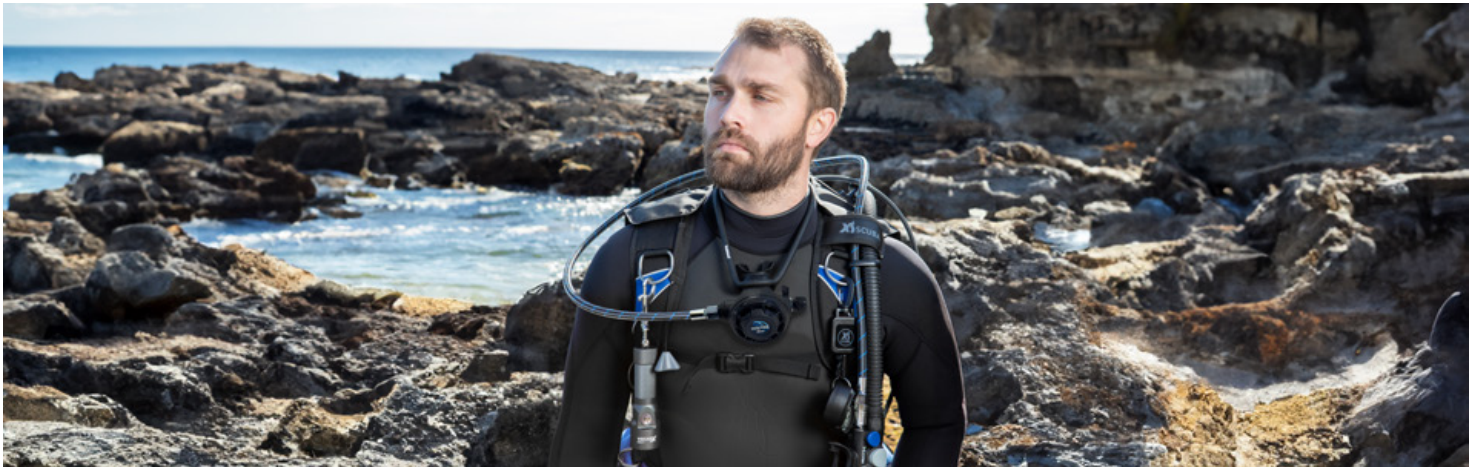

Rebuildable & Adjustable OPV - Stainless Steel

- Easy to adjust from 150 to 250 psi
- Factory preset at 200 psi (+/- 10 psi)
- All stainless steel construction with Viton O-rings
- Machined Delrin cap protects the adjustment point
- Compact relief valve releases pressure in the event of an over pressurization of the first stage
- Fits standard 3/8"-24 UNF MP regulator port

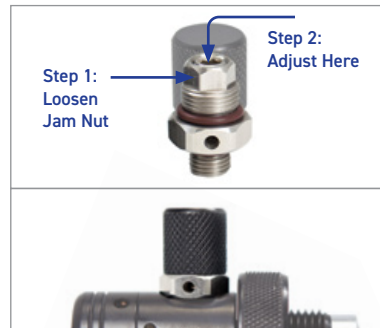

Part #	Description	Retail
AC396	Rebuildable & Adjustable OPV - Over Pressure Valve	42.00
AC396K	Service Kit for AC396	12.00

Standard OPV - Over Pressure Valve - Brass

- Factory set at 175 to 185 psi for pressure release (non-adjustable)
- Compact relief valve releases pressure in the event of an over pressurization of the first stage
- Chrome brass construction with Viton O-rings
- Stainless steel internal spring
- Non-rebuildable
- Fits standard 3/8"-24 UNF MP regulator port



Part #	Description	Retail
AC395	Standard Over Pressure Valve	15.00

Standard Spin-On Yokes

- Convert a DIN connection to a yoke connection
- Fits all 200 to 300 bar DIN valves
- All brass construction

Deluxe Spin-On Yoke - 316 SS

- Female DIN threads of 316 grade stainless steel
- Designed to withstand heavy-duty use



Part #	Description	Retail
AC370	Standard Spin-On Yoke - Chrome	50.00
AC370BK	Standard Spin-On Yoke - Black Chrome	60.00
AC370SS	Deluxe Stainless Steel Spin-On Yoke	66.00



Shown with optional Rook Knife

SeaBlazer BC

The SeaBlazer is a high-quality, weight-integrated, jacket style BC. By having the air-cell wrap around the diver's torso, it will provide vertical orientation at the surface while providing excellent stability and comfort underwater. The SeaBlazer offers the best ergonomics of any BC in the market today with easy-to-reach touch points, swivel shoulder buckles, and friendly, accessible pockets.

- Catch n' Release™ weight system for the easiest loading weight pockets
 - Secure your weights with visual, audible and tactile confirmation
 - Single-pull release for safety
- Large utility pockets on either side have lowered zippers with large pull bobs for easy access
- Non-ditchable trim weight pockets found on the back of the SeaBlazer (except size XS) increase the overall weight capacity as well as provide better positioning in the water. They secure with hook-and-loop flaps and side-release clips
- Swivel shoulder buckles allow the SeaBlazer to move with you while providing an optimal fit
- Enlarged thumb loops allow ease of adjustment while wearing thick gloves
- The two-piece waist band is adjustable in the back to accommodate a wide range of waist sizes
- The tank band features a stainless steel cam buckle with external adjustment
- Comes with XS Scuba's Micro Inflator but a MultiMax breathable inflator option is available
- A scooped opening on the top, front of the right lobe is perfect for stowing and deploying an octopus. The octopus remains visible and secure throughout the dive
- Some divers may find it useful to run their instruments behind the left pocket and out the scooped opening on the top, front of the lobe
- A tank positioning strap allows you to set your cylinder to the correct height every time
- An integrated carrying handle is built into the back pack
- 6 stainless steel D-rings provide many attachment options
- 3 dump valves are available: a cable-activated rapid exhaust valve at the top of the airway, a right shoulder pull dump and a lower, rear pull dump
- Knife mounting grommets on the left side accommodate an XS Scuba BC knife



Part #	Description	Size	Lift Values (lbs/N)	Retail
BC231	SeaBlazer Buoyancy Compensator	XS	24 / 100	540.00
BC233		SM	27 / 120	
BC235		MD	30 / 130	
BC237		LG	40 / 170	
BC239		XL	46 / 200	



PROBLEM

Traditional Back Weight

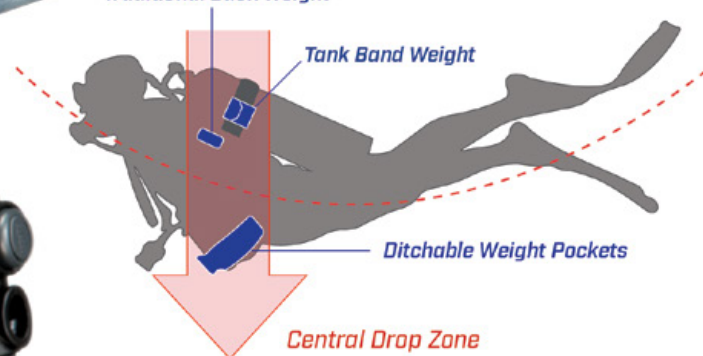

Concentrating all the lead in the center of the body leads to poor body positioning, drag, increased air consumption and a sore lower back.

SOLUTION

Phantom SL Shoulder Weights

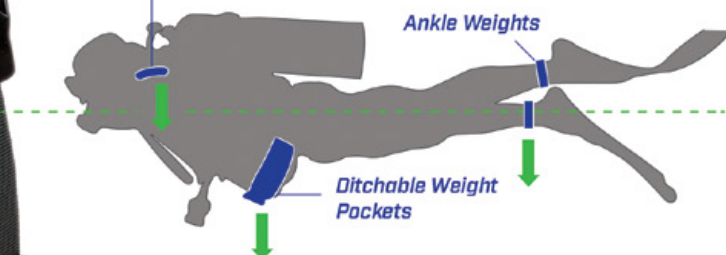

Spreading your lead to the front and back distributes the load. You'll swim more streamlined and more comfortably! The Phantom SL allows you to Spread Your Lead!



The new Phantom SL BC makes it easy to Spread Your Lead. Thin weight pockets, located high up on the back of the shoulders, isolate up to two, 2lb weights on each side.

While 2 lb mesh shot bags will fit, XS Scuba strongly encourages using 2 lb hard blocks for a lower profile.

Each Phantom SL BC includes a pair of 1lb ankle weights to help you Spread Your Lead.



Phantom SL BC

The Phantom SL BC is a weight-integrated back-inflation BC. It will improve your buoyancy by allowing you to Spread Your Lead (see previous page). The Phantom SL offers many unique features making it comfortable and fun to dive.

- Comes with XS Scuba's Micro Inflator but a MultiMax breathable inflator option is available
- Weight pockets mounted up high on the shoulders for excellent lead spreading capability
 - Each pocket holds 2 x 2 lb weights (hard or mesh weights)
 - A total of 8 lbs (3.6 kg) can now be moved forward on the diver's body
- An internal, heavy-duty polyethylene chassis extends well into the shoulders to support the shoulder weight pockets and to keep diver's shoulders comfortable
- Includes a pair of 1 lb (454 g) ankle weights
- Catch n' Release™ weight system for the easiest loading weight pockets with single pull ditch for safety
 - Secure your weights with visual, audible and tactile confirmation
- Swivel shoulder buckles optimize the routing of the shoulder straps for a more custom fit
- Enlarged thumb loops accommodate gloved thumbs to more easily pull down on the shoulder straps
- Increased back padding for added comfort
- Lowered tank band integrates into BC's waistband to transfer the cylinder's weight to the hips
- Tank band features a stainless steel separating cam buckle for easy cylinder change-out
- No hard backpack allows the cylinder to stay in close, next to your body which makes the cylinder feel lighter
- Drop-down right pocket can hold slates or a small flashlight
- Knife mounting grommets on the left pocket
- 6 stainless steel D-rings provide many attachment options
- Only 4 sizes are needed to fit divers from XXS to XXL

**BUY 5
GET ONE
FREE**

**SPREAD YOUR LEAD WITH
PHANTOM^{SL}**



Shown with optional MultiMax Breathable Inflator & Rook Knife



Deploy the right pocket to hold larger items



The stainless cam buckle separates for quick change out of cylinders



Swivel shoulder buckles allow a custom fit

Part #	Description	Size	Lift Values (lbs/N)	Retail
BC332	Phantom SL Buoyancy Compensator	XXS/XS	25 / 110	580.00
BC334		SM/MD	25 / 110	
BC336		ML/LG	35 / 150	
BC338		XL/XXL	35 / 150	

Pony Pac Harness

The Pony Pac is a quick, easy way to hit the water. It is a great choice for anyone who doesn't require an air bladder on their harness.

The Pony Pac has been upgraded with a downsized Catch n' Release™ weight pocket system. Custom receptacles on the lower back allow the user to easily click weight pockets into place. They can be ditched with a simple pull.

Used by:

- First Responders for rapid entry into the water
- Boat owners for in-water maintenance
- Instructors for Intro to diving classes
- Fits 13, 19, 30 and 40 cu ft pony cylinders with 4.0 - 5.4 in (102 - 137 mm) diameters
- Can accommodate up to 10 lbs (4.5 kg) of lead weight
- Extra-large thumb loops for cinching down shoulder straps
- Rolled neoprene neck collar for maximum comfort
- Knife mounting grommets on waist band are ideal for the Rook Knife (p/n KN500)
- 2-way adjustable sternum strap
- Can be upgraded to a compact, travel BC with the addition of a Companion Air Cell (p/n BC530)



Low profile Catch n' Release™ weight pockets



Part #	Description	Size	Waist Size	Weight Pockets	Retail
BC503	Pony Pac Harness	Small	25" to 35"	Two 5 lbs	210.00
BC507		Regular	30" to 50"		
BC509		X-Large	45" to 55"		

Turn Your PonyPac Into a Companion BC

Part #	Description	Retail
BP500	Tank Bands (Pair) - Standard Length 6.9" to 8.0" diameter	40.00
BC530	Companion Air Cell with Inflater, QD Hose and airway hold-down	225.00

Companion The Ultra Compact Travel BC

By adding a compact wing to the Pony Pac, you have the Companion BC, an ultra-compact travel BC. The Companion BC is 40% lighter than traditional BC's weighing in at only 5 lbs (2.3 kg). Take advantage of the versatility that a removable air cell can offer.

- Back inflation design with 30 lbs (13.6 kg) of lift
- Two rear weight pockets have an exclusive Catch n' Release™ mounting system. Each pocket is capable of holding 5 lbs (2.3 kg)
- Includes two standard length tank cam straps (p/n BP500)
- Fits cylinder diameters of 6.9 - 8.0 in (175 - 203 mm)
- Rear pull dump on lower, right side
- Removable epaulette (airway hold down)
- Knife mounting grommets are ideal for Rook Knife (p/n KN500)
- Two-way adjustable sternum strap
- Extra-large thumb loops for cinching down shoulder straps



Part #	Description	Size	Lift	Weight Pockets	Retail
BC503C	Companion BC	Small	30 lbs	Two 5 lbs	470.00
BC507C		Regular			
BC509C		X-Large			

Triton

The Triton BC is a non weight-integrated, wrap-around style jacket. While it will certainly be favored by lockers, schools and resorts because of its price and features, it does not look institutional or entry level in any way. In fact, quite the contrary. It is stylish and feature-rich. It is a BC that you will be proud to display in your retail store. We invite you to compare these features with other BC's in this category.

- The air cell is made from 1000D material for maximum wear and abrasion resistance
- An external sizing tag, which can be removed if not wanted, is useful in locker situations
- The two-piece cummerbund can be adjusted for size or be replaced with a different size altogether
- Chest strap – included
- Lower, rear dump valve – included
- Right shoulder pull dump – included
- 2 large utility pockets are available for your accessories
- Includes 3 large D-rings to attach your favorite accessories
- A scooped opening on the top front of the right lobe is perfect for stowing and deploying an octopus
- Some divers may find it useful to run their instruments behind the left pocket and out the scooped opening on the top, front of the left lobe
- Triton's stability is provided by a backpack with an integrated carry handle
- The compressed foam back pad provides comfort
- An integrated positioning strap allows you to set your Triton with your preferred cylinder height dive after dive
- Comes standard with XS Scuba's Micro inflator, a drift pin design that increases reliability by not relying on an internal schrader valve
- Available in 5 sizes XS – XL



Part #	Description	Size	Lift Values (lbs/N)	Retail
BC121	Triton BC	X-Small	27 / 120	365.00
BC123		Small	30 / 130	
BC125		Medium	36 / 160	
BC127		Large	40 / 170	
BC129		X-Large	46 / 200	

Turtle Snorkeling Vest

Add safety to your snorkeling experience. Snorkeling vests save lives by providing a head's up resting platform and by making the snorkeler highly visible to boaters.

- Provides surface flotation for snorkelers
- Chest mounted oral inflator
- 420D urethane laminated nylon
- Easy oral inflation/deflation
- Waist and crotch strap included



Part #	Description	Diver's Weight	Retail
SV01	Adult Snorkeling Vest	100 to 240 lbs	56.00
SV02	Junior Snorkeling Vest	50 to 100 lbs	52.00



HIGHLAND ENGINEERED QUALITY 20 lb Wing Travel Package

Perhaps you're a fan of diving plates and wings instead of traditional BC's, but you don't like the bulk and weight when heading off to tropical destinations, or you're a minimalist who likes the ultimate in streamlined setups, Highland has the package for you!

We mate our 1 lb ultralight aluminum travel plate with our streamlined travel wing, add a cushy back pad and two tank bands to bring you the minimal, lightweight travel package. **The Highland HL20W-PKG only weighs 7.65 lbs**

The Highland Travel Package includes:

- **Aluminum Travel Backplate** (p/n HL801-TP)
This dog bone shaped plate weighs in at a mere 1 lb 1 oz (495g)
Includes webbing slide bars
- **20 lb Travel Wing** (p/n HL20W)
Features low-profile dump valves and cylinder anti-roll bars
- **Custom Fitted Back pad** (p/n HL808)
Includes an integrated storage pocket and 4 attachment book screws
- **Tec/Rec Harness** (p/n HL803)
Includes crotch strap and all necessary hardware
- **Shoulder Pads** (p/n HL805)
Made from quality 5 mm neoprene
- **Tank Bands with SS Cam Buckles - Pair** (p/n HL211)
Stainless steel makes these cam buckles indestructible.



Part #	Description	Retail
HL20W-PKG	20 lb Wing Travel Package	660.00
Suggested Add-ons:		
HL802	Stainless Single Tank Adapter	77.00
HL209	Side-Slide Weight Pockets (Pair)	104.00
HL250	Highland Weight Plates - 2 Pack	27.00
HL510	SS Book Screw - 1 Complete Set	11.00
ASSEMBLE	Assemble the harness to the backplate	-



Back Pad for Aluminum Travel Plate

Travel plates are often used in the tropics where minimal thickness exposure suits are worn. As such, a back pad is used so that the diver doesn't have to feel the hard plate on their back. The Highland Back Pad is custom made specifically for the ultra-lightweight Aluminum Travel Plate. It is neutrally buoyant, has a large utility pocket and includes the attachment hardware.

- Attaches to the Highland Aluminum Travel Plate (p/n HL801-TP) using 4 plastic book screws (included)
- An integrated large utility pocket is ideal for carrying lift devices or other accessories
- The comfort comes from the use of 3D open cell mesh foam. Open cell foam does not add inherent buoyancy and it drains and dries quickly
- Backside is made of 1000D nylon



Dimensions

11 x 15 in
28 x 63.5 cm



Premium quilted padding



Storage pocket

Part #	Description	Retail
HL808	Back Pad for Aluminum Travel Plate (incl. hardware)	55.00



20 lb Travel Wing

The Highland Travel Wing makes a nice addition to a diver's modular plate and wing system. Due to its streamlined profile and light weight, it lends itself well to traveling or to those dives when you just feel like being a minimalist.

- Includes 25 in (63.5 cm) Miflex QD Carbon hose
- 16 in (41 cm) corrugated hose with K-style inflator
- Low-profile, rapid-exhaust dump on the upper left
- Low-profile dump on the lower inside left
- Integrated carrying handle on the top center
- Removable tank anti-roll assembly
- Vent at the top center allows air to quickly escape between the inner and outer bag
- Spiral hose retainer loop
- Outer bag made from 1000D nylon with PU coating
- Inner bladder made from 210D nylon
- 4 slots allow direct attachment to cylinder with nylon cam bands
- 2 sets of 11 in (280 mm) centered grommets
- Length (deflated): 21.7 in (55.1 cm)
- Width (deflated): 14.2 in (36.1 cm)
- Weight: 2.3 lbs (1.04 kg)



Part #	Description	Retail
HL20W	20 Pound Travel Wing	330.00

HIGHLAND ENGINEERED QUALITY Tec/Rec Harness

Highland Tec/Rec Harnesses come complete with high-quality hardware. From the dedicated harness webbing to the shoulder pads, the quality of this harness is evident throughout.

- Available with your choice of backplate
- Classic minimalist harness
- Simple, continuous weave design can be easily customized
- The 2 in (50 mm) nylon web is specifically sourced for harness and crotch strap application

- Includes two 5 mm thick neoprene shoulder pads (p/n HL805)
- Includes 6 D-ring attachment points (2 waist, 2 shoulders, 2 crotch strap)
- Includes adjustable crotch strap (p/n HL810)
- Assembly not included

The harness is also available by itself (p/n HL803), without the backplate or shoulder pads. It includes the crotch strap, waist buckle, D-rings and retainers.



Aluminum Travel Plate

Aluminum

Stainless Steel

Harness Only

Part #	Description	Retail
HL800-TP	Tec/Rec Harness/ Backplate Complete - Aluminum Travel	187.00
HL800-AL	Tec/Rec Harness/Backplate Complete - Aluminum	210.00
HL800-SS	Tec/Rec Harness/Backplate Complete - Stainless Steel	242.00
HL803	Tec/Rec Harness Only (no backplate or shoulder pads)	73.00
ASSEMBLE	Assemble Harness To Plate	-

HIGHLAND ENGINEERED QUALITY 37 lb Single Wing / 45 lb Twin Wing

Highland Wings are built strong, using the best fabrics and materials. The designs are versatile and cross-compatible so that they easily adapt to other brands of backplates and harnesses.

Highland Wings feature streamlined, low-profile hardware including a low-profile elbow on the upper left.

- 360° full circle design allows quick left/right gas transfer
- 4 cam slots allow direct attachment to cylinder with nylon cam bands
- Each model has a carrying handle strong enough to lift the attached cylinder(s)
- "K-Style" tech inflator on an elliptical 19 in (23 cm) corrugated hose
- 25 in (63.5 cm) Miflex quick-disconnect hose (carbon color)
- The 37 lb single wing has an anti-roll bar assembly (removable)

New for 2024, the 45 lb Wing has been updated with:

- Flattened elbow at the top
- Streamlined OPV
- Flattened blanking cap
- Added carrying handle
- Highland green thread accents
- Highland embroidery on the back right
- Added a pull bob to the dump valve



37 Pound Wing

45 Pound Twin Wing

Part #	Description	Retail
HL37W	37 Pound Wing	370.00
HL45W	45 Pound Twin Wing	419.00
BPH22	Corrugated Oval Hose 1 x 19 in Length	22.00

HIGHLAND ENGINEERED QUALITY Backplates

The backplate is the chassis that supports the entire kit. Technical divers choose Highland backplates because of the attention given to the small details such as beveled edges and slot placement.

- All edges are beveled to protect the harness webbing
- The 3 holes at the top of the plate offer variable height adjustment for air cell and cylinder mounting. In addition, a corresponding lower oval slot allows for lower band bolts that may be misaligned
- Slots at bottom for use with 1 in (2.5 cm) or 2 in (5 cm) crotch strap
- 3/8 in (9.5 mm) accessory mounting holes along the sides and bottom
- Hardware not included



Aluminum Travel Backplate

- 5052 aluminum alloy with tungsten anodized finish
- 1 lb 1oz (495 g)
- Slide bars included



Aluminum Backplate

- 6061 aluminum alloy with black anodized finish
- 1 lb 11oz (765 g)

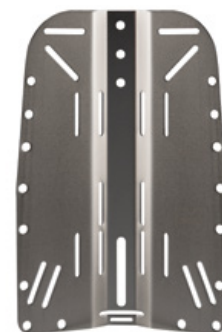

Stainless Steel Backplate

- 304 stainless-steel, 11-gauge (.115 in / 3 mm)
- 5 lbs (2.3 kg)

Part #	Description	Retail
HL801-TP	Aluminum Travel Backplate	123.00
HL801-AL	Aluminum Backplate - Black	128.00
HL801-SS	Stainless Steel Backplate	165.00

HIGHLAND ENGINEERED QUALITY SS Book Screw

- Attach various accessories, such as mesh carry pouch to plate
- One complete set, male & female
- Stainless steel, non-rusting construction
- Will pass through 3/8 in (9.5 mm) hole
- Includes friction O-rings



Dimensions

Head diameter: 0.74 in (18.8 mm)
 Shaft diameter: 0.33 in (8.4 mm)
 Internal height: 0.43 in (10.9 mm)

Part #	Description	Retail
HL510	SS Book Screw - 1 Complete Set	11.00

HIGHLAND ENGINEERED QUALITY Plastic Book Screws, 4-Pack

A low-cost alternative to the HL510 stainless steel model above, use these plastic book screws for a wide range of applications, such as joining a single cylinder plate and wing when a single tank adapter will not be used.

- Will pass through 3/8 in (9.5 mm) hole
- Non-corrosive, durable plastic material for long life
- Includes 4 complete book screws



Dimensions

Head diameter: 0.74 in (18.8 mm)
 Shaft diameter: 0.36 in (9.1 mm)
 Internal height: 0.35 in (8.9 mm)

Part #	Description	Retail
HL515	Plastic Book Screw, 4-Pack	10.00

HIGHLAND ENGINEERED QUALITY STA - Single Tank Adapter

- 14 gauge .074 in (1.9 mm) 316 grade stainless steel
- A quick, easy way to mount a single cylinder to a backplate and harness
- Attaches to cylinder with two cam bands
- Center-to-center distance of 11 in (28 cm)
- Includes hardware
- Weight: 13 oz (369 g) without hardware



Includes

BK802

- 2 ea. 5/16-18 x 1" carriage bolts 18-8 SS
- 2 ea. 5/16-18 x 1.5" carriage bolts 18-8 SS
- 2 ea. 5/16 x 3/4" OD flat washers 18-8 SS
- 2 ea. 5/16-18" wing nuts 18-8 SS



Dimensions
 3.2 x 11.8 in
 8 x 30 cm

Part #	Description	Retail
HL802	Stainless Steel Single Tank Adapter	77.00
BK802	Replacement Hardware	28.00



Slide Bars for Backplates

With continuous weave harnesses, it can often be difficult to tighten the shoulders by pulling on the waist straps. This is due to friction caused by the tortuous path that the webbing makes as it goes through the dual slots in the backplate. The Slide Bars mount on the back of the plate, between the slots. The slick, rounded surface minimizes the friction and makes the waist straps easier to pull through.



Part #	Description	Retail
HL816	Slide Bars for Backplates (Pair)	8.00



Delrin Speed Nuts

- Strong, durable alternative to traditional wingnuts
- Knurled gripping surface for easier disassembly
- Available in two thread sizes:
 - 3/8" - fits Highland bands hardware p/n SB725
 - 5/16" - fits Highland bands hardware p/n SB800

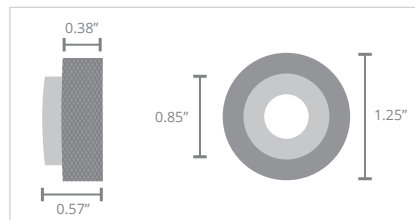

Part #	Description	Retail
HL407	3/8" Delrin Speed Nuts (Pair)	16.00
HL408	5/16" Delrin Speed Nuts (Pair)	
HL410	M8 x 1,5 Delrin Speed Nuts (Pair)	
HL415	M8 x 1,25 Delrin Speed Nuts (Pair)	



Shoulder Pads [Pair]

Add comfort and protect your exposure suit, by covering your web harness shoulder straps with these Highland shoulder pads.

- Made from quality 5 mm neoprene
- Simply slide over 2 in (50 mm) webbing
- Glued and stitched
- Seams reinforced with bar tack stitching



Part #	Description	Retail
HL805	Highland Shoulder Pads (Pair)	18.00



Bulk Harness Webbing

- High-grade 2 in (50 mm) nylon webbing sourced specifically for building technical harnesses
- Softer than standard weight belt webbing
- Less abrasive on exposure suits
- 50 yard (45.7 m) roll



Part #	Description	Retail
NW50-HW	Bulk Harness Webbing - 50 yds (45.7 m)	



SS Harness Buckle

- 304 stainless steel harness buckle
- Designed to fit 2 in (50 mm) webbing



Part #	Description	Retail
HL414	SS Harness Buckle	20.00

HIGHLAND *Original* Weight Plates - 2 Pack

Highland Weight Plates are a quick and easy way to add blocks of lead to a 2 in (50 mm) wide piece of webbing such as a harness or weight belt. This will allow for fine tuning of your weight requirement without having to do any disassembly. **Don't settle for imitations made from inferior materials and bungees.**

- Includes 2 plates and 4 pieces of green bungee
- Plate is molded from rugged glass-filled nylon for maximum durability
- Recommended for 1, 2, 3 and 4 lb blocks of lead

For use with Lace-Thru Weights

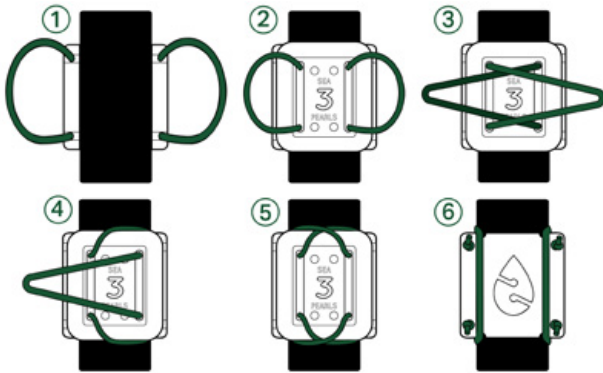

Part #	Description	Retail
HL250	Highland Weight Plates - 2 Pack	27.00

HIGHLAND *ENGINEERED QUALITY* Bottom-Drop Weight Pockets [Pair]

- Full size weight pocket to add lead weights to a diving harness
- Load weights from the top zipper
- Uses the single-pull Catch n' Release™ dump mechanism
- Attaches to 2 in (50 mm) webbing
- Each pocket holds up to 15 lbs (7 kg) of lead weights



Part #	Description	Retail
HL208	Bottom-Drop Weight Pockets (Pair)	117.00

HIGHLAND *ENGINEERED QUALITY* Side-Slide Weight Pockets [Pair]

Side-Slide weight pockets are an easy way to add lead to a 2 in (50 mm) webbed harness, usually associated with a backplate and a wing.

- Large, side-squeeze 2 in (50 mm) buckles on the front of the pocket for easy release of weights
- Adjustment strap with D-ring to cinch down for snug fit
- Each pocket holds up to 12 lbs (5.5 kg) of lead weights
- The dual grommet tail on the back allows for attachment to the backplate. This keeps pouches from sliding forward
- A 30° angled web retainer on the back provides an option to mount the weights at an upward angle, a feature desirable to small waisted divers
- Book screws not included



Part #	Description	Retail
HL209	Side-Slide Weight Pockets (Pair)	104.00
BPH51	Inner Replacement Pocket - Black (Single)	30.00



HIGHLAND ENGINEERED QUALITY **Crotch Strap**

- Built from 54 in (137 cm) of 2 in (50 mm) harness webbing
- Rivet construction for maximum durability
- Included with Tec/Rec Harness (HL803)
- Includes front and back D-rings and size adjuster



Part #	Description	Retail
HL810	Crotch Strap	31.00

HIGHLAND ENGINEERED QUALITY **Sternum Strap**

- Built from 1.5 in (38 mm) webbing - 11 in (280 mm) long
- 2 x 4 in (5 x 10 cm) SS sliders for extreme durability
- 4 SS rivets hold everything together
- Includes 2 serrated stays to accommodate thinner webbing and 2 D-rings for attachment points



Part #	Description	Retail
HL815	Sternum Strap	60.00

Standard Backpack

- Traditional single tank backpack
- Blow-molded plastic construction
- 2 in (50 mm) black harness webbing
- Adjustable tank band with cam buckle
- Will accommodate 6.9 in (175 mm) to 8.0 in (203 mm) cylinders
- SS quick-release at shoulder and waist
- Built-in carry handle
- Overall length 15 in (38 cm)

*Consider adding a pair of HL805
Highland Shoulder Pads (pg. 28)*



Part #	Description	Retail
BP100	Standard Backpack	76.00
HL805	Highland Shoulder Pads (Pair)	18.00



Tank Bands with SS Cam Buckles [Pair]

Now two models to choose from, separating and non-separating!

These rugged tank bands, featuring stainless steel cam buckles, are indestructible. An integrated, large protective pad protects the surface finish on your cylinder.

- Designed to fit on cylinders with diameters of 6.9 in (175 mm) to 8.0 in (203 mm)
- Enlarged protective webbing lays behind the buckle to protect the cylinder finish
- Backside of webbing has integrated anchor pad, which eliminates tank slippage
- Traditional 3-slotted cam buckle made from marine grade 316 stainless steel
- The HL201 separating design allows for quick cylinder changeouts
- The HL211 is a traditional, non-separating design



Part #	Description	Retail
HL201	Tank Bands with SS Cam Buckles (Pair)	83.00
HL211	Tank Bands with Non-separating SS Cam Buckles (Pair)	

Tank Band with SS Buckle [Single]

The XS Scuba tank band with the separating stainless steel buckle is the easiest, most secure way to attach your cylinder to your BC.

- Standard length, as found on SeaBlazer, fits most BC's that have standard backpacks
- Shorter length, as found on Phantom, fits most BC's without hard packs
- Both versions fit 6.9 in (175 mm), 7.25 in (184 mm) & 8.0 in (203 mm) diameter cylinders
- Cam buckle made of marine grade 304 stainless steel
- The buckle separates for easy removal of BC from cylinder
- Tension can be adjusted while on cylinder
- Integrated anchor pad prevents tank slippage



Part #	Description	Retail
BP505	Tank Band w/ SS Buckle (Single) - Standard Length - 31.25 in (793 mm)	62.00
BP510	Tank Band w/ SS Buckle (Single) - Phantom BC Length - 28.25 in (717 mm)	

Tank Bands [Pair]

- Injection-molded cam buckles
- Molded from nylon with glass fill
- Standard length has overall webbing length of 40 in (102 cm)
- Short length has overall webbing length of 26 in (66 cm)



Part #	Description	Cylinder Diameter	Retail
BP500	Tank Bands (Pair) - Standard Length	6.9 to 8.0 in	40.00
BP550	Tank Bands (Pair) - Short Length	4.0 to 5.25 in	40.00

There is good reason why this Highland inflator is found on technical rigs from the Jersey Coast to the Florida Caves. It is strong and dependable. Its reliability comes from its simplicity. Best of all, the unit is completely serviceable in the field by changing out the Power Shaft Cartridge using the Highland Inflator Tool. Available as a complete airway assembly or just the lower unit only.

HIGHLAND ENGINEERED QUALITY Complete Airway

- 19 in (48 cm) corrugated, oval profile, hose
- Simple 90° connecting elbow on top
- Retaining collar fits coarse thread manifolds
- Includes elastic LP hose retainer band and sealing gasket
- Replacement for most wings

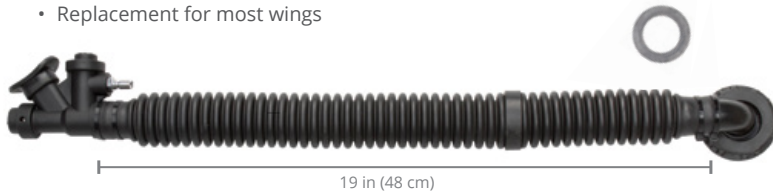

Power Shaft Replacement Cartridge (For Field Service)

BPH20



Highland Inflator Tool



TL126

HIGHLAND ENGINEERED QUALITY Inflator

- Strong and reliable
- Able to service in the field with TL126 Inflator Tool and BPH20 Replacement Cartridge
- Attaches to 1 in (25 mm) diameter corrugated hose
- Comes as shown with cable attachment pin



Lower Unit (Only)

Part #	Description	Retail
BPH30	Highland Complete Airway	78.00
HL205	Highland Inflator - Lower Unit	52.00
TL126	Highland Inflator Tool	14.50
BPH20	Power Shaft Complete - Field Service	20.00
BKH01	Service Kit, Highland Inflator	12.00

The XS Scuba Micro Inflator is a compact work horse that gets the job done every time. Its reliability comes from its solid drift pin design. This design eliminates the use of an internal schrader valve, known for corrosion and reliability issues. Available as a complete airway assembly or just the lower unit only.

XS SCUBA Complete Micro Airway

- Fits all current XS Scuba BC's as well as many other brand models
- Includes sealing gasket, rapid exhaust OP valve with cable, corrugated hose, and LP hose clip
- Retaining collar fits coarse thread manifolds
- Available in 3 hose lengths: 14, 16 & 18 in (35.5, 41 & 46 cm)



XS SCUBA Micro Inflator

- Drift pin design for reliability, no internal schrader valve
- Attaches to 3/4 in (19 mm) diameter corrugated hose
- Comes as shown with cable attachment pin
- Great item for Save-a-Dive Kit



Lower Unit (Only)

Part #	Description	Retail
BP600-14	Micro-Inflator - Complete - 14 in	78.00
BP600-16	Micro-Inflator - Complete - 16 in	
BP600-18	Micro-Inflator - Complete - 18 in	
BP605	Micro Inflator - Lower Unit	47.00
BK02	Service Kit for Micro Inflator Airway, Complete	20.00

Replacement Weight Pockets



Pony Pac (p/n BP47)



Phantom/SeaBlazer (p/n BP55)



Nekton (p/n BP50)

Part #	Description	Retail
BP47	Pony Pac Pockets (Pair)	44.00
BP55	Weight Pocket - Catch n' Release™ - Single	32.00
BP50	Weight Pocket - X-Lock™ - Single	30.00

Cummerbund Extender

Did your BC cummerbund shrink? We have the solution.

- Adds up to 10 in (25 cm)

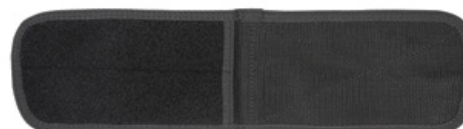

Part #	Description	Retail
BP45	Cummerbund Extender - Standard	11.00

Cummerbund - Replacement

- Fits SeaBlazer and Triton BC's
- Includes both right and left sides



Part #	Description	Size	Retail
BP41-XS	Cummerbund Replacement	Extra Small	34.00
BP41-SM		Small	
BP41-MD		Medium	
BP41-LG		Large	
BP41-XL		Extra Large	

Rear Pull Dump Assembly

BP52 - 2 in (50 mm) Pull Dump Assembly - Old Style

- Pre-assembled to 4 in (100 mm) length
- Fits Highland wings, XS Scuba BC's, lift bags and SMBs with 2 in (50 mm) diameter, grey manifolds with fine threads



BP52

BP58 - 2 in (50 mm) Pull Dump Assembly - Current Style

- Comes un-assembled with 20.5 in (77.5 cm) of cord
- Can be configured into a right shoulder pull dump or a lower rear pull dump
- Fits Highland wings, XS Scuba BC's, lift bags and SMBs with 2 in (50 mm) diameter, clear manifolds with coarse threads



BP58

Part #	Description	Retail
BP52	2 in (50 mm) Pull Dump Assembly - Old Style	12.00
BP58	2 in (50 mm) Pull Dump Assembly - Current Style	11.00

Corrugated Hose for Breathable Inflator

- 16 in (41 cm) length with 3/4 in (19 mm) upper diameter and 1 in (25 mm) lower diameter
- This is an alternate corrugated hose for XS Scuba BC's which allows you to attach a breathable inflator, with 1 in (25 mm) bore



Part #	Description	Retail
BP636-16	16 in (41 cm) Corrugated Hose 3/4 in (19 mm) Upper x 1 in (25 mm) Lower	16.00



QuikVu Console – Pressure, Depth & Compass

QuikVu Consoles are compact, lightweight, and have attachment points on both sides. The thin, braided HP hose is lighter weight and more flexible than a traditional rubber hose.

Front Side

Depth Gauge (p/n GP31, GP31M)

- Depth gauge scale is 0 to 200 ft (0 to 60 m)
- Includes a maximum depth indicator needle
- Luminescent gauge face
- Glass-filled nylon housing with shatterproof lens

Pressure Gauge (p/n GP28, GP28M)

- Pressure gauge scale is 0 to 5000 psi (0 to 400 bar)
- The Beryllium-Copper spiral-wound coil ensures greater reliability and compactness
- Bourdon Tube design provides accurate measurements under depth
- Luminescent gauge face

Back Side

Compass (p/n GP40)

- Large gun sight style viewing window allows for easy and accurate navigation
 - Compasses have strong magnets to guarantee accuracy and quick response times
 - Reads accurately over a wide tilt range
 - The luminescent dial rests on a precision sapphire jewel
 - Large, secure 360° ratcheting bezel
- Includes 32 in (81 cm) braided HP hose
 - CE 0598:EN 250 and UKCA 0120:EN250 certified



Part #	Description	Units	Retail
GA310	QuikVu Console - 3 Gauge	psi/feet	245.00
GA310M		bar/meters	

QuikVu Console – Pressure & Depth

Ergonomic styling gives the Combo 2-Gauge a slim profile and comfortable grip. Integrated attachment points on both sides provide multiple options for gear configuration. The thin, braided HP hose is lighter weight and more flexible than a traditional rubber hose.

Depth Gauge (p/n GP31, GP31M)

- Depth gauge scale is 0 to 200 ft (0 to 60 m)
- Includes a maximum depth indicator needle
- Luminescent gauge face
- Glass-filled nylon housing with shatterproof lens

Pressure Gauge (p/n GP28, GP28M)

- Pressure gauge scale is 0 to 5000 psi (0 to 400 bar)
- The Beryllium-Copper spiral-wound coil ensures greater reliability and compactness
- Bourdon Tube design provides accurate measurements under depth
- Luminescent gauge face
- Includes 32 in (81 cm) braided HP hose
- CE 0598:EN 250 and UKCA 0120:EN250 certified



Part #	Description	Units	Retail
GA210	QuikVu Console - Press/Depth	psi/feet	210.00
GA210M		bar/meters	

QuikVu Console – Pressure & Compass

This stylish, low-profile combo pairs beautifully with any wrist-mount dive computer. Integrated attachment points on both sides provide multiple options for gear configuration. The thin, braided HP hose is lighter weight and more flexible than a traditional rubber hose.

Compass (p/n GP40)

- Large gun sight style viewing window allows for easy and accurate navigation
- Compasses have strong magnets to guarantee accuracy and quick response times
- Reads accurately over a wide tilt range
- The luminescent dial rests on a precision sapphire jewel
- Large, secure 360° ratcheting bezel

Pressure Gauge (p/n GP28, GP28M)

- Pressure gauge scale is 0 to 5000 psi (0 to 400 bar)
- The Beryllium-Copper spiral-wound coil ensures greater reliability and compactness
- Bourdon Tube design provides accurate measurements under depth
- Luminescent gauge face
- Includes 32 in (81 cm) braided HP hose
- CE 0598:EN 250 and UKCA 0120:EN250 certified



Part #	Description	Units	Retail
GA220	QuikVu Console - Press/Compass	psi/feet	210.00
GA220M		bar/meters	

QuikVu Pressure Gauge

The slim, ergonomic design of this pressure gauge fits perfectly in the hand. Attachment points on either side provide multiple options for gear configuration. The thin, braided HP hose is lighter weight and more flexible than a traditional rubber hose.

Pressure Gauge (p/n GP28, GP28M)

- Pressure gauge scale is 0 to 5000 psi (0 to 400 bar)
 - The Beryllium-Copper spiral-wound coil ensures greater reliability and compactness
 - Bourdon Tube design provides accurate measurements under depth
 - Luminescent gauge face
- Includes 32 in (81 cm) braided HP hose
 - CE 0598:EN 250 and UKCA 0120:EN250 certified



Part #	Description	Units	Retail
GA110	QuikVu Pressure Gauge	psi	132.00
GA110M		bar	

QuikVu Wrist Depth Gauge

The QuikVu Wrist Depth Gauge has been scaled down, making it smaller than the average wrist gauge. The glove-friendly buckle and strap assembly has depth-compensating corrugated ribs to keep the gauge snug at depth.

Depth Gauge (p/n GP31, GP31M)

- Depth gauge scale is 0 to 200 ft (0 to 60 m)
 - Includes a maximum depth indicator needle
 - Luminescent gauge face
 - Glass-filled nylon housing with shatterproof lens
- CE 0598:EN 250 and UKCA 0120:EN250 certified



Part #	Description	Units	Retail
GA455	QuikVu Wrist Depth Gauge	feet	94.00
GA455M		meters	

QuikVu Replacement Modules

Part #	Description	Retail
GP28	QuikVu Pressure Gauge Module (PSI)	84.00
GP28M	QuikVu Pressure Gauge Module (BAR)	84.00
GP31	QuikVu Depth Gauge Module (200 ft)	84.00
GP31M	QuikVu Depth Gauge Module (60 m)	84.00
GP40	QuikVu Compass Module	55.00

QuikVu Boots and Mounts

Part #	Description	Retail
GP30	QuikVu Pressure Gauge Boot	17.00
GP32	QuikVu 2-Gauge Boot	34.00
GP33	QuikVu 3-Gauge Boot	34.00
GP34	QuikVu Press/Compass Boot	34.00
GP41	QuikVu Wrist Boot/Strap for Depth Gauge	24.00
GP35	QuikVu Wrist Boot/Strap for Compass	20.00
GP37	QuikVu Hose-Mount Boot for Compass	30.00
GP38	QuikVu Bungee Mount w/ Bungee Cord	23.00
GP39	QuikVu Clip n Go Boot for Compass	23.00

Orca Console – 3 Gauge

- The front side has a pressure gauge and a compass
- The reverse side has a depth gauge
- Available in imperial or metric version
- All gauge & compass faces are luminescent for low light conditions

Pressure Gauge

- 0 to 5000 psi (0 to 350 bar)
- Includes 32 in (81 cm) high pressure rubber hose
- Attachment clip ready

Compass

- Top and side reading
- Uses a double magnet for quicker, precise readings
- Large ratcheting bezel is easy to operate with gloves
- Oil-filled to stabilize magnetic card

Depth Gauge

- 0 to 230 ft (0 to 70 m)
- Maximum depth wire indicator needle
- Air-filled, steel membrane mechanism



CE

Part #	Description	Units	Retail
GA305	Orca Console - 3 Gauge	psi/feet	242.00
GA305M		bar/meters	

Orca Pressure Gauge

- 0 to 5000 psi (0 to 350 bar)
- Highly accurate Bourdon Tube design
- Includes 32 in (81 cm) high pressure rubber hose
- Attachment clip ready
- Built-in safety plug on the back



CE

Part #	Description	Units	Retail
GA105	Orca Pressure Gauge	psi	120.00
GA105M		bar	

Orca Console Parts

Part #	Description	Retail
GP23	Orca Pressure Gauge Module (PSI)	65.00
GP23M	Orca Pressure Gauge Module (BAR)	65.00
GP24	Orca Depth Gauge Module (230 ft)	60.00
GP24M	Orca Depth Gauge Module (70 m)	60.00
GP26	Orca Pressure Gauge Boot	13.00
GP25	Orca 3-Gauge Console Boot	26.00

Legacy Pressure Gauge Module

This common pressure gauge module comes from Pelagic Pressure Systems. In addition to XS Scuba, it fits in many different brands of older console boots, including, but not limited to Aqua Lung / US Divers, Oceanic, and Sherwood.

- 0 – 5000 psi (0 – 420 bar)
- Built in thermometer (°F/°C)
- Includes HP spool (p/n GP10)
- Luminescent gauge face

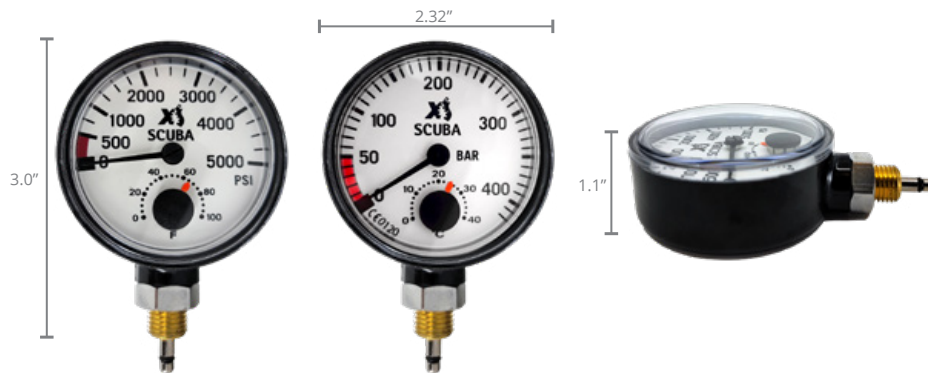

Part #	Description	Units	Retail
GP01	Legacy Pressure Gauge Module	5000 psi	84.00
GP01M		420 bar	

HIGHLAND

ENGINEERED QUALITY

Built in Italy by a third generation of craftsmen, Highland analog gauges offer robust precision to the technical diver. From brass processing with CNC machines to welding, assembly and final underwater testing, each gauge is tested individually to ensure maximum diver safety during the dive.



Pressure/Compass Combo w/ Miflex Hose

Pressure Gauge

- Chromed brass housing w/ Lexan lens (Thin-Line SPG)
- 0 to 5000 psi (0 to 400 bar)
- Luminescent gauge face
- Airspool with Viton O-rings

Miflex Hose

- 32 in (81 cm) Miflex Carbon HD braided outer layer
- Manufactured in Italy

Attachment Clips

- Two loops for attachment

Compass

- Highly accurate movement
- Tilt of up to 18°
- Top and side reading
- Large ratcheting bezel
- Luminescent face
- Northern hemisphere



Part #	Description	Units	Retail
HL307	Miflex Pressure/Compass Combo	psi	231.00
HL307M		bar	
GP27	Compass Module	-	68.00



Pressure/Depth Combo w/ Miflex Hose

Pressure Gauge

- Chromed brass housing with Lexan lens (Thin-Line SPG)
- 0 to 5000 psi (0 to 400 bar)
- Luminescent gauge face
- Airspool with Viton O-rings

Miflex Hose

- 32 in (81 cm) Miflex Carbon HD braided outer layer
- Manufactured in Italy

Depth Gauge

- Chromed brass housing ring
- Oil filled
- 0 to 220 ft (0 to 70 m)
- Luminescent gauge face
- Maximum depth indicator needle
- Depth Gauge dimensions: 2 in (50 mm) diameter x 7/8 in (2.2 cm) wide

COMPACT SIZE



CE



Attachment Clips

- Two loops for attachment

Part #	Description	Units	Retail
HL300	Miflex Two Gauge Console	psi/feet	275.00
HL300M		bar/meters	
GP14	Depth Gauge Module	0 - 220 feet	84.00
GP14M	Depth Gauge Module (Metric)	0 - 70 meters	



Thin-Line Pressure Gauge [Complete]

- Nickel-plated brass housing enclosed in rubber boot
- Includes 32 in (81 cm) rubber or Miflex braided hose
- Available in:
 - Imperial: 0 to 5000 psi
 - Metric: 0 to 400 bar
 - Dual scale
- Airspool includes Viton O-rings
- Boot has 3 attachment points



CE



Part #	Description	Units	Retail
HL311	Thin-Line Pressure Gauge Complete with 32 in (81 cm) Rubber HP Hose	psi	148.00
HL311M		bar	
HL311DS		Dual Scale	
HL311-MFX	Thin-Line Pressure Gauge Complete with 32 in (81 cm) Miflex HP Braided Hose	psi	160.00
HL311M-MFX		bar	
HL311DS-MFX		Dual Scale	



Thin-Line SPG

- Nickel-plated brass housing
- Durable, Lexan lens
- Airspool with Viton O-rings included
- Luminescent gauge face
- Wide 240° sweep from 0 to 5000 psi
- Metric version is from 0 to 400 bar
- Dual Scale version from 0 - 5000 psi / 0 - 350 bar
- HP hose is not included
- Manufactured in Italy

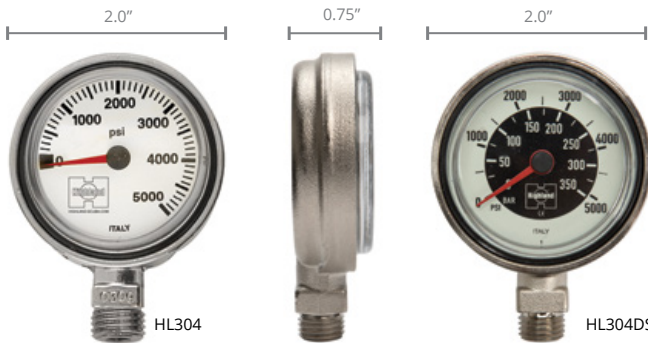

Optional Boot

CE

Part #	Description	Units	Retail
HL304	Thin-Line SPG	psi	80.00
HL304M		bar	
HL304DS		Dual Scale	
HL305-BK	Protective Boot - Black		14.00
HL305-GN	Protective Boot - Green		

HIGHLAND ENGINEERED QUALITY PVD Coated Brass & Glass Gauges

Highland has expanded its popular line of Brass & Glass analog gauges with the addition of two models that sport a PVD coating. PVD (Physical Vapor Deposition) coatings dramatically improve the appearance and durability of a product. This hard-as-nails coating is 300 times harder than chrome.

- PVD over double chrome mirror plating for best look & durability
- Available in imperial units (PSI) or in a dual-scale (PSI / BAR)
- 2 in (5 cm) diameter
- Preferred gauge for technical diving due to high level of accuracy and reliability
- Range graduations: 0 – 5000 psi / 0 – 350 BAR



Part #	Description	Units	Retail
HL301-PVD	Highland 2 in (5 cm) SPG PVD Finish	Imperial	142.00
HL301DS-PVD		Dual Scale	
GP11	2 in (5 cm) Pressure Gauge Boot - Black		15.00

HIGHLAND ENGINEERED QUALITY 2 in and 2.5 in Brass & Glass SPG

- 2 in (5 cm) and 2.5 in (6.4 cm)
- Double chrome mirror plated
- Tempered glass lens
- Airspool included with Viton O-rings
- Luminescent gauge face
- Wide 270° sweep from 0 to 5000 psi (0 to 360 bar)
- Bright, white face - easy to read
- Built-in over pressure relief for safety
- HP hose is not included
- Manufactured in Italy

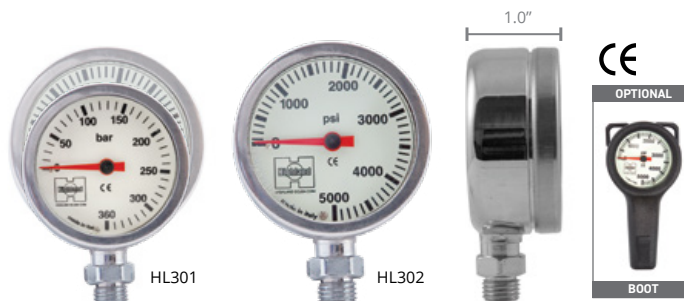

Part #	Description	Units	Retail
HL301	2 in (5 cm) Brass & Glass SPG	psi	114.00
HL301M		bar	
GP11	2 in (5 cm) Pressure Gauge Boot - Black		15.00
HL302	2.5 in (6.4 cm) Brass & Glass SPG	psi	114.00
HL302M		bar	
GP08	2.5 in (6.4 cm) Pressure Gauge Boot - Black		17.00

HIGHLAND ENGINEERED QUALITY 2 in Brass & Snap SPG

- Unique SPG with integrated stainless steel shackle bolt snap
- Includes two optional breakaway straps
- 2 in (50 mm) nickel plated brass housing with tempered glass lens
- Airspool with Viton O-rings included
- Luminescent gauge face
- Wide 270° sweep from 0 to 5000 psi
- Metric version is from 0 to 360 bar
- Built-in over pressure relief for safety
- Manufactured in Italy

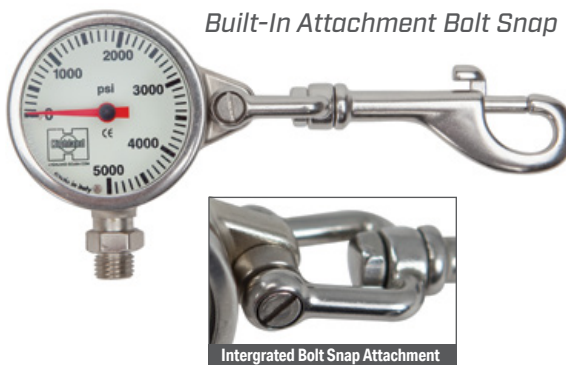

Built-In Attachment Bolt Snap



CE

Part #	Description	Units	Retail
HL309	2 in (5 cm) Brass and Snap SPG	psi	115.00
HL309M		bar	
HL309-BA	Break-Away Strap Replacement Kit (includes 5 pieces)		11.00

Pony Bottle Gauge

This ultra-compact, submersible pressure gauge is ideal for pony bottles and emergency breathing systems. It provides a clear pressure reading at your regulator's HP port.

- Working Pressure: 4500 psi (310 bar)
- 0 – 5000 psi scale with accuracy at 5% tolerance of full scale
- Operating Depth: 330 ft+ (100 m+)
- Polycarbonate lens
- Beryllium-copper (BeCu) tube design provides accuracy and reliability
- Built-in over-pressure relief plug
- 7/16"-20 UNF threads with an EPDM ring



Part #	Description	Retail
GA055	Pony Bottle Gauge	72.00

HIGHLAND ENGINEERED QUALITY Mini Tech Gauge

- Available as gauge only, or in kit form
 - The gauge will thread directly into a regulator's first stage HP port
 - With a complete kit, it will thread onto the end of a HP hose
- Kit includes gauge, rubber boot, in-line adapter and airspool
- 0 to 5000 psi (0 to 350 bar)
- Gauge and airspool include Viton O-rings
- Attractive clamshell packaging (kit only)



Part #	Description	Units	Retail
HL501	Mini Tech Gauge - KIT	psi	60.00
HL501M		bar	
HL502	Mini Tech Gauge - ONLY	psi	44.00
HL502M		bar	

HIGHLAND ENGINEERED QUALITY Rubber Boot for Mini Tech SPG

- Sold by itself or as part of the HL501 Mini Tech Gauge Kit
- Fits all 1 in (2.54 cm) diameter gauges that are approximately 0.88 in (22 mm) deep



Part #	Description	Retail
HL503	Rubber Boot for Mini Tech SPG	5.00

HIGHLAND ENGINEERED QUALITY Inline Gauge Adapter

- Included with Mini Tech Gauge Kit
- Use to mount a Mini Tech Gauge to HP hose
- Inline (180°) with the HP hose
- Airspool with Viton O-rings included



Part #	Description	Retail
HL403	Inline Gauge Adapter	38.00

HIGHLAND ENGINEERED QUALITY 90 Degree Gauge Adapter

- Not included with Mini Tech Gauge Kit
- Use to mount a Mini Tech Gauge to HP hose
- Right angle (90°) with the HP hose
- Airspool with Viton O-rings included



Part #	Description	Retail
HL403-90	90 Degree Gauge Adapter	34.00

HIGHLAND ENGINEERED QUALITY Airspools

- Required swivel between HP hose and SPG
- Brass construction

HL303
Viton O-rings



GP10
Buna-N O-rings



Part #	Description	Retail
HL303	Highland Airspool w/ Viton O-rings	6.00
GP10	XS Scuba Airspool w/ Buna-N O-rings	5.00

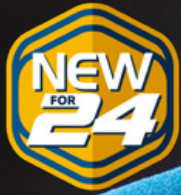

QUIKVU

COMPASSES

- Large, secure 360° ratcheting bezel
- Large gun sight style viewing window allows for easy and accurate navigation
- Compass has a luminescent dial resting on a precision sapphire jewel
- Reads accurately over a large tilt range
- Strong magnets guarantee accuracy and quick response time



Wrist Mount p/n GA405

- Stylish and functional wrist strap



Hose Mount p/n GA415

- Use on standard rubber HP hose or using the adapter sleeve, clamp on to a thin 8mm Miflex braided hose



Retractable Compass p/n GA425

- Attach to diver with snap hook or split ring



Bungee Mount p/n GA435

- Mount with one continuous loop or two separate loops for redundancy



Clip n Go Compass p/n GA445

- This versatile mounting boot can be attached using a retractor, coil, or lanyard

Part #	Description	Retail
GA405	QuikVu Compass - Wrist Mount	77.00
GA415	QuikVu Compass - Hose Mount	88.00
GA425	QuikVu Compass - Retractable	110.00
GA435	QuikVu Compass - Bungee Mount	77.00
GA445	QuikVu Compass - Clip n Go	77.00

Wrist/Hose Mount Compass

- Top and side reading
- Large ratcheting bezel
- Luminescent gauge face
- Rubber boot with wrist strap
- Includes hose mount option
- Uses standard compass module (p/n GP03T)



Hose Mount Included

CE

Part #	Description	Retail
GA400	Wrist/Hose Mount Compass	60.00
GP21	Wrist Mount & Strap Only	14.00

Compass Module - SuperTilt

- Highly accurate
- More range of tilt than Standard Module (p/n GP03T)
- Top and side reading
- Large ratcheting bezel
- Luminescent gauge face
- Same dimensions as the standard compass module



Side View Window



Dimensions
0.60 x 2 in
1.5 x 5 cm

CE

Part #	Description	Retail
GP03	SuperTilt Compass	55.00



NavPro Compass

- Superior tilt potential of +/- 30°
- Complete: compass module, bungee mount & bungee cord
- 30 in (76 cm) length of 4 mm bungee cord
- Mount with one continuous loop or two separate loops for redundancy
- Luminescent easy-to-read compass card
- Top and side reading
- Manufactured in Italy



CE

Part #	Description	Retail
HL310	NavPro Compass	104.00



Bungee Mount Compass

- Complete: compass module, bungee mount & bungee cord
- 30 in (76 cm) length of 4 mm bungee cord
- Mount with one continuous loop or two separate loops for redundancy
- Luminescent face
- Top and side reading
- Large ratcheting bezel
- Manufactured in Italy



CE

Part #	Description	Retail
HL306	Bungee Mount Compass	86.00
GP18	Compass Module for HL306	68.00

Miflex LP Braided Hoses

- Lightweight and flexible low pressure hoses
- Multi-layer construction
- Excellent resistance to abrasion
- Kink-resistant design
- Approved for use for use with up to 40% oxygen
- Individually tested at the factory
- EN250 approved
- Individually marked with the Miflex logo and date code
- Manufactured in Italy
- Inner liner is made from polyether-based polyurethane, not PVC, as found in lesser-priced imitators



Patent No. 8,381,772



Orange
Red
Pink
Mellow Yellow
Blue
Hi-Vis Yellow
Carbon
Green
White
Purple
Black

REGULATOR HOSES 3/8"-24 UNF MALE to 9/16"-18 UNF FEMALE

Part #	Overall Length	Color	Retail
MLP06-BK	6"	Black	42.00
MLP09-BK	9"	Black	42.00
MLP18-BK	18"	Black	44.00
MLP22-BK	22"	Black	44.00
MLP24-BK	24"	Black	44.00
MLP26-BK	26"	Black	46.00
MLP26-BU	26"	Blue	46.00
MLP30-BK	30"	Black	48.00
MLP30-BU	30"	Blue	48.00
MLP30-CN	30"	Carbon	48.00
MLP30-OR	30"	Orange	48.00
MLP30-PK	30"	Pink	48.00
MLP30-PR	30"	Purple	48.00
MLP30-RD	30"	Red	48.00
MLP30-WH	30"	White	48.00
MLP30-YL	30"	Hi-Vis Yellow	48.00
MLP36-BK	36"	Black	48.00
MLP36-BU	36"	Blue	48.00
MLP36-MY	36"	Mellow Yellow	48.00
MLP36-YL	36"	Hi-Vis Yellow	48.00
MLP40-BK	40"	Black	49.00
MLP40-BU	40"	Blue	49.00
MLP40-GN	40"	Green	49.00
MLP40-MY	40"	Mellow Yellow	49.00
MLP40-YL	40"	Hi-Vis Yellow	49.00
MLP44-BK	44"	Black	52.00
MLP48-BK	48"	Black	54.00
MLP60-BK	60"	Black	59.00
MLP84-BK	84"	Black	71.00
MLP84-BU	84"	Blue	71.00
MLP84-YL	84"	Hi-Vis Yellow	71.00

Miflex DS (Dual Swivel) LP Hoses

Are you tired of feeling like your hose is trying to push your regulator out of your mouth? Get a Miflex DS (Dual Swivel) hose and take comfort and flexibility to a new level.



- The 60° swivel ball joint on the second stage end eliminates the push and pull on the mouthpiece

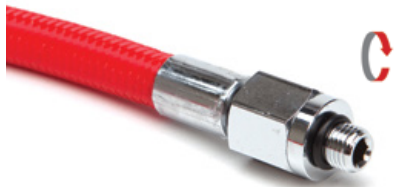

- The 360° swivel on the first stage end prevents hose twisting and optimizes hose direction

- Increase comfort and reduce jaw fatigue
- Chromed brass construction with Viton O-rings
- Overall length = 28 in (71 cm)
- Approved for use with up to 40% oxygen



Part #	Description	Color	Length	Retail
MDS28-BK	Miflex DS (Dual Swivel) LP Hoses	Black	28"	90.00
MDS28-BU		Blue		
MDS28-CN		Carbon		
MDS28-GN		Green		
MDS28-PK		Pink		
MDS28-PR		Purple		
MDS28-RD		Red		
MDS28-WH		White		
MDS28-YL		Yellow		
AK999		Service Kit for Swivel Ball Joint		
TL142	Pin Spanner for Swivel Ball Joint	n/a	n/a	n/a



miflex hoses

The Miflex XT-Tech Hoses are designed to meet the needs of technical divers. One of the many features of these Kevlar® reinforced hoses, is a smooth exterior finish to prevent abrasion on the back of the neck.

Miflex XT-Tech Hoses

Developed specifically for technical and professional divers, the XT-Tech hoses have a smooth outer layer and reduced flexibility compared to the Xtreme hoses.

- The smooth outer surface prevents abrasion around the neck
- Less flexibility and negative buoyancy allow the longer hoses to stay in place
- Outer polyester layer has Kevlar® yarn reinforcement to make the hose stronger and more durable
- Lighter in weight than traditional rubber hoses
- End fittings are made of sea water resistant electroless nickel plated brass
- Like all Miflex hoses, they are 100% leak tested and produced on fully automated assembly lines
- Inner liner is made from polyether based polyurethane, not PVC, as found in lesser-priced imitators
- Approved for use with up to 40% oxygen



Part #	Description	Length	Retail
MXT22	Miflex XT-Tech Regulator Hose	22"	53.00
MXT30		30"	57.00
MXT40		40"	62.00
MXT60		60"	75.00
MXT84		84"	88.00
Part #	Description	Length	Retail
MXTQD09	Miflex XT-Tech QD Hose	9"	57.00
MXTQD22		22"	64.00
MXTQD25		25"	70.00
MXTQD32		32"	75.00

Miflex High Pressure Carbon HD Hoses

Miflex HP hoses are 35% thinner (7.8 mm) and about half the weight of traditional rubber hoses. These quality hoses use electroless nickel plated brass fittings on both ends. They are approved for use with up to 40% oxygen.



FEMALE FITTING

- 7/16 in x 20 female threads
- Strain relief with shock absorber
- 14 mm deep airspool well



MALE FITTING

- 7/16 in x 20 male threads
- Strain relief with shock absorber
- Green Viton O-ring



Part #	Description	Length	Retail
MHP06-CN	Miflex High Pressure Carbon HD Hoses	6"	56.00
MHP24-CN		24"	58.00
MHP30-CN		30"	62.00
MHP32-CN		32"	64.00
MHP36-CN		36"	66.00
MHP40-CN		40"	73.00
MHP48-CN		48"	77.00

Miflex BC/Drysuit Quick Disconnect Hoses

Miflex BC Drysuit hoses are lightweight and flexible, making it easier to route your hoses. The most popular sizes now come in four colors.

- 7 lengths available
- The knurled collar makes it easy to attach and remove
- Approved for use with up to 40% oxygen

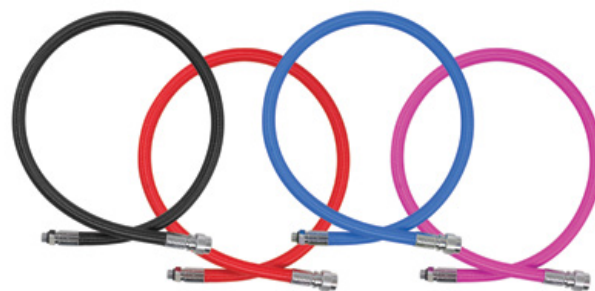

Part #	Description	Color	Length	Retail
MQD14-BK	Miflex BC/Drysuit Quick Disconnect Hoses	Black	14"	48.00
MQD18-BK		Black	18"	
MQD22-BK		Black	22"	49.00
MQD22-BU		Blue		
MQD22-PK		Pink		
MQD22-RD		Red		
MQD25-BK		Black	25"	54.00
MQD25-BU		Blue		
MQD25-PK		Pink		
MQD25-RD		Red		
MQD29-BK		Black	29"	56.00
MQD29-BU		Blue		
MQD29-PK		Pink		
MQD29-RD		Red		
MQD32-BK		Black	32"	57.00
MQD32-BU		Blue		
MQD32-PK		Pink		
MQD32-RD		Red		
MQD36-BK		Black	36"	59.00

Rubber Hoses - Low & High Pressure

Not all rubber hoses are created equal. Go with the quality difference and choose XS Scuba rubber hoses. Our hoses are designated with our logo on the fitting and a date code so you will know the history of the hose.

Easy Grip Wide Collar For QD Hoses



- Easy attachment and removal
- Flattened side to prevent clearance issues
- Standard schrader valve installed
- Standard collar attachment

Gauge High Pressure



Regulator Low Pressure Hose

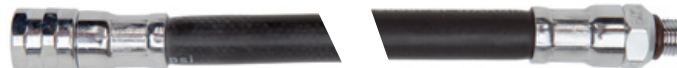

BC / Drysuit QD Low Pressure



Part #	Description	Length	Retail	
HP06	Gauge High Pressure 7/16"-20 UNF Male to 7/16"-20 UNF Female	6" (15 cm)	38.50	
HP22		22" (56 cm)	42.50	
HP24		24" (61 cm)	44.50	
HP26		26" (66 cm)	46.50	
HP32		32" (81 cm)	50.50	
HP36		36" (91 cm)	54.50	
HP42		42" (107 cm)	58.50	
HP32MM		7/16"-20 UNF Male to 3/8"-24 UNF Male	32" (81 cm)	55.50
Part #		Description	Length	Retail
LP22		Regulator Low Pressure 3/8"-24 UNF Male to 9/16"-18 UNF Female	22" (56 cm)	30.50
LP24	24" (61 cm)		30.50	
LP26	26" (66 cm)		30.50	
LP28	28" (71 cm)		35.50	
LP30	30" (76 cm)		35.50	
LP32	32" (81 cm)		36.50	
LP36	36" (91 cm)		36.50	
LP36YL (yellow)	36" (91 cm)		36.50	
LP40	40" (102 cm)		38.50	
LP40GN (green)	40" (102 cm)		39.50	
LP40YL (yellow)	40" (102 cm)		38.50	
LP60	60" (152 cm)		44.50	
LP84	84" (213 cm)		46.50	
Part #	Description		Length	Retail
LP06QD	BC / Drysuit QD Low Pressure 3/8"-24 UNF Male to BC QD Female		6" (15 cm)	30.50
LP15QD		15" (38 cm)	31.50	
LP22QD		22" (56 cm)	32.50	
LP24QD		24" (61 cm)	32.50	
LP26QD		26" (66 cm)	33.50	
LP30QD		30" (76 cm)	37.50	
LP36QD		36" (91 cm)	39.50	

1/4" NPT Bailout Hoses

- Used in conjunction with brass or SS couplers to make bailout whips
- Maximum pressure 350 psi
- Fittings laser-etched with date code

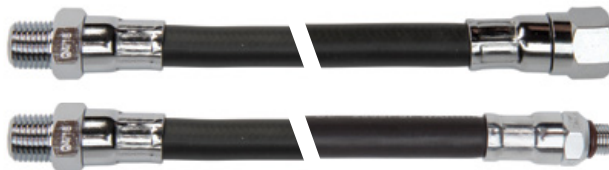

Part #	Description	Retail
SH08	8" LP Bailout Hose - 1/4" NPT Male x 9/16"-18 UNF Female (regulator second stage)	27.00
SH10	10" LP Bailout Hose - 1/4" NPT Male x 9/16"-18 UNF Female (regulator second stage)	29.00
SH30	30" LP Bailout Hose - 1/4" NPT Male x 3/8"-24 Male UNF (regulator first stage)	36.00
SH36	36" LP Bailout Hose - 1/4" NPT Male x 3/8"-24 Male UNF (regulator first stage)	38.00

Hose Hook

Protect Your Hoses From Premature Failure

- Secure attachment of a clip without causing potential damage to the hose
- Includes 2 break-away straps

- For use with all low pressure scuba hoses with an approximate 0.5 in (13 mm) diameter

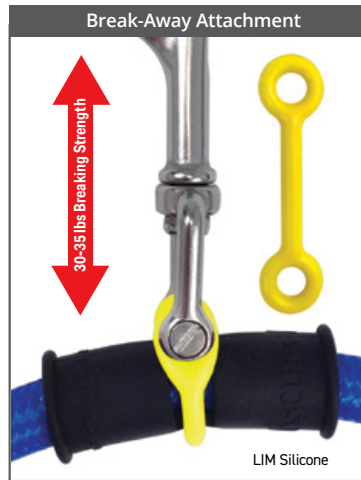
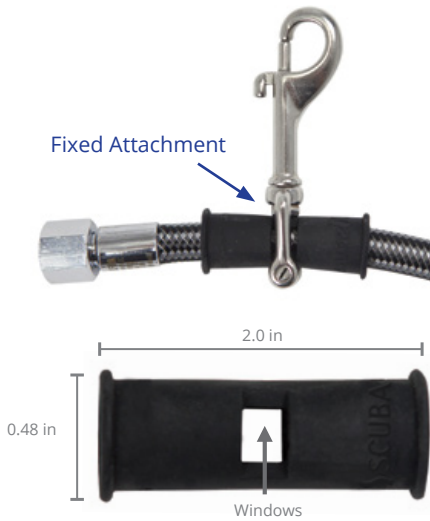

Prevent Damage to Low Pressure Hoses



The attachment of a clip or accessory to a scuba hose can cause damage. Often, too much pressure is exerted on the hose surface, damaging the outer and/or inner layers reducing the hose strength. Damage to the inner layer can cause a break-down of material and potential reduced flow of gas. The use of any method other than the Hose Hook for attachment of clips/ accessories will void the warranty of all Miflex and XS Scuba hoses.

Part #	Description	Retail
AC956	Hose Hook - Includes SS Clip, Silicone Sleeve and 2 Break-Away Straps	20.50
AC956-BA	Break-Away Strap Replacement Kit (includes 5 pieces)	11.50

Hose Clips

- All three models have a 2-way swivel
- Delrin and stainless steel construction

*Standard hose diameter is 0.4 in (11 mm) to 0.5 in (13 mm)



Retains two standard diameter* low or high pressure hoses
p/n AC952



Retains three standard diameter* low or high pressure hoses
p/n AC953



Retains one Miflex HP braided hose (8 mm) and one standard diameter* low or high pressure hose
p/n AC955

Part #	Description	Retail
AC952	Two Hose Clip	8.50
AC953	Three Hose Clip	
AC955	Miflex Hose Clip	

Hookah Hoses

Miflex Braided

- Lightweight and flexible
- Resistant to abrasion
- Easy to coil and pack



Yellow Rubber

- High-visibility yellow
- Durable
- Easy-to-clean



HOOKAH SECOND STAGE

SEE PAGE 12



Part #	Description	Overall Length	Color	Retail
MLP300-BK	Miflex Hookah Length Regulator Hoses 3/8"-24 UNF Male to 9/16"-18 UNF Female	300 in (25 ft)	Black	220.00
MLP600-BK		600 in (50 ft)		319.00
MLP1200-BK		1200 in (100 ft)		440.00
LP300YL	Yellow Rubber Hookah Length Regulator Hoses 3/8"-24 UNF Male to 9/16"-18 UNF Female	300 in (25 ft)	Yellow	150.00
LP600YL		600 in (50 ft)		230.00
LP1200YL		1200 in (100 ft)		380.00
LP1800YL		1800 in (150 ft)		490.00

"EZ" QD Connector

- Convert any standard regulator hose to a BC quick disconnect hose
- Also fits drysuit valves that have an international type stem
- Installs on the second stage end of a regulator hose
- Six point attachment with six ball bearings
- "EZ" QD design, just push to attach - no need to pull back the collar
- Wide easy grip collar
- Chromed brass construction with Viton O-rings
- Low pressure use only - below 200 psi



Fits this stem
(not included)

Part #	Description	Retail
AC900	EZ Quick-Disconnect Adapter	28.00
AK900	Service Kit for AC900	8.50

"CEJN Style" Drysuit QD Connector

- Convert any standard regulator hose to a "Drysuit Style" QD hose
- Installs to the second stage end of a regulator hose
- Chromed brass construction with Viton O-rings
- Low pressure use only - below 200 psi

Compatible with: Swedish CEJN couplers as found on many drysuit inflation valves, Zeagle Octo Plus and Beuchat Venturi.



Fits this stem
(not included)

Two Machined Grooves

Part #	Description	Retail
AC920	"Drysuit Style" Quick-Disconnect Adapter	35.00
AK920	Service Kit for AC920	8.50

"Aqualung/SeaQuest Style" QD Connector

- Convert any standard regulator hose to a "Aqualung/SeaQuest Style" QD hose
- Installs to the second stage end of a regulator hose
- Chromed brass construction with Viton O-rings
- Low pressure use only - below 200 psi

Compatible with: Aqualung/SeaQuest Air Source, Oceanic Air XS 2, US Divers Air Mic and Mares Air Control.

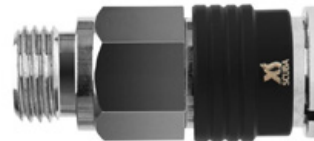

Fits this stem
(not included)

Three Machined Grooves

Part #	Description	Retail
AC925	"Aqualung/SeaQuest" Quick-Disconnect Adapter	35.00
AK925	Service Kit for AC925	8.50

"ScubaPro Style" QD Connector

- Convert any standard regulator hose to a "ScubaPro Style" QD hose
- Installs to the second stage end of a regulator hose
- Chromed brass construction with Viton O-rings
- Low pressure use only - below 200 psi

Compatible with: ScubaPro Air 2, Tusa Duo Air, Atomic SS1, Sherwood Gemini and Zeagle Octo-Z.



Fits this stem
(not included)

Part #	Description	Retail
AC930	"ScubaPro Style" Quick-Disconnect Adapter	35.00
AK930	Service Kit for AC930	8.50

"MultiMax" QD Connector

- Convert any standard regulator hose to a MultiMax breathable inflator QD hose
- Installs to the second stage end of a regulator hose
- Compact size with a brass release sleeve
- Low pressure use only - below 200 psi



Fits this stem
(not included)

Part #	Description	Retail
RP370-44	"MultiMax" QD Connector	37.00
RP370-45	Service Kit for Multimax QD Connector	4.00

Hose Adapters



LP Angle Adapters

- Installs between low pressure regulator hose and second stage
- Increase comfort and reduce jaw fatigue
- Used to improve regulator hose routing
- Often used to set up underarm routing of primary regulator hose
- Chromed brass construction with Viton O-rings
- Low pressure use only – below 200 psi



AC910



AC911

Part #	Description	Retail
AC910	90° Right Angle Adapter	43.00
AC911	110° Angle Adapter	

Second Stage Swivel Adapters

- Install between low pressure regulator hose and second stage
- Reduce hose torque on the second stage leading to increased comfort and reduced jaw fatigue and clenching
- Rotating swivel action
- Assembled with Viton O-rings
- Low pressure use only – below 200 psi



AC912



AC921



AC922

Part #	Description	Material	Retail
AC912	Swivel Adapter	Brass	55.00
AC921	Swivel Adapter	Stainless	88.00
AC922	Right Angle Adapter With Swivel	Brass	60.00
AK912	Service Kit For AC912, AC921, AC922		8.50

First Stage Quick Disconnect

- Quick and convenient way to change hose lengths between dives
- Installs between 1st stage and LP regulator hose
- Lock-down screw to prevent accidental disconnection
- Flow rate = 800 lpm
- Low-pressure use only – below 200 psi

First Stage Quick Disconnect – Male Only

- Install on multiple LP regulator hoses for quick swaps



Part #	Description	Retail
AC998	First Stage Quick Disconnect - Complete	80.00
AC999	First Stage Quick Disconnect - Male Only	21.00

Brass 2nd Stage Quick Disconnect

- Add a quick-disconnect to most regulators or full face masks
- Installs between low pressure regulator hose and second stage
- Lock-down screw to prevent accidental disconnection
- Low pressure use only - below 200 psi

Brass 2nd Stage QD - Male Only

- Install on multiple second stage regulators for quick swaps



Part #	Description	Retail
AC990	Brass 2nd Stage Quick Disconnect - Complete	68.00
AC991	Brass 2nd Stage QD - Male Only	21.00
AK990	Service Kit for AC990	8.50

Stainless 2nd Stage Quick Disconnect

- Add a quick-disconnect to most regulators or full face mask
- Installs between low pressure regulator hose and second stage
- "Click & Lock" to prevent accidental disconnection
- All stainless steel construction with Viton O-rings
- Low pressure use only - below 200 psi

Stainless 2nd Stage QD - Male Only

- Install on multiple second stage regulators for quick swaps



Part #	Description	Retail
AC992	Stainless Steel 2nd Stage Quick Disconnect - Complete	115.00
AC995	Stainless Steel 2nd Stage Quick Disconnect - Male Only	44.00
AK992	Service Kit for AC992	8.50

Brass 2nd Stage Quick Disconnect with Brass Swivel

- Using the same brass coupler as the AC990 above, this product provides the additional benefit of adding a brass swivel to the male portion
- Installs between LP hose and 2nd stage, or full face mask
- The rotating swivel action reduces torque on the 2nd stage, leading to increased comfort
- Low pressure use only – below 200 psi

Brass 2nd Stage QD w/ Swivel Male Only

- Install on multiple 2nd stage regulators or full face masks

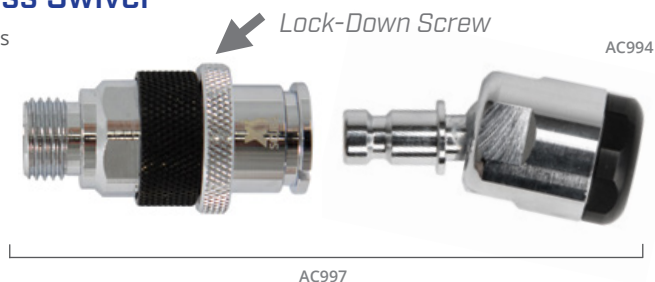

Part #	Description	Retail
AC997	Brass 2nd Stage Quick Disconnect with Brass Swivel - Complete	115.00
AC994	Brass 2nd Stage Quick Disconnect with Swivel - Male Only	62.00
AK997	Service Kit for AC997	8.50

Assorted LP Adapters and Extenders

- Brass construction with black chrome finish
- Viton O-rings (where applicable)
- Low pressure use only – below 200 psi



AC940

LP Port Adapter

- 1/2"-20 male to 3/8"-24 female
- Allows the connection of a standard LP regulator hose (3/8"-24) into a large size regulator LP port (1/2"-20)
- (3/8"-24) into a large size regulator LP port (1/2"-20)



AC919

LP Hose Adapter

- 9/16"-18 male to 3/8"-24 male
- Convert a standard LP regulator hose so that both ends have 3/8" male threads



AC960

Hose to Hose Connector

- 3/8"-24 female to 9/16"-18 male
- Connect two regulator hoses together to make one long regulator hose



AC970

LP Port Extender

- 3/8"-24 female to 3/8"-24 male
- Extend the placement of the LP port away from the first stage

Part #	Description	Retail
AC940	LP Port Adapter 1/2"-20 Male to 3/8"-24 Female	16.00
AC919	LP Hose Adapter 9/16"-18 Male to 3/8"-24 Male	
AC960	Hose to Hose Connector 3/8"-24 Female to 9/16"-18 Male	
AC970	LP Port Extender 3/8"-24 Female to 3/8"-24 Male	

LP Hose Splitter

- Attach to the second stage end of one low pressure regulator hose
- Allows the attachment of two low pressure regulator hoses (first stage ends)
- One 9/16"-18 male inlet to two 3/8"-24 female outlets
- Chromed brass construction with Viton O-ring
- Low pressure only - below 200 psi



Part #	Description	Retail
AC918	LP Hose Splitter	42.00

Inline First Stage Hose Swivel

Most regulator hoses have a natural curve to them. When the hose curves back, away from the diver, it can be annoying. This handy little swivel will allow the natural curve of your hose to sweep forward, over your right shoulder. It also makes the scuba removal and replacement drill much easier to execute as it eliminates hose twisting.

- Chromed brass construction with Viton O-rings

One Port
Inline



Part #	Description	Retail
AC903	(1) 3/8"-24 Male Inlet to (1) 3/8"-24 Female Outlet	22.00

LP Port Swivel Adapters

- Reroute, or increase, the number of low pressure hoses coming off your first stage
- Chromed brass construction with Viton O-rings
- Low pressure only – below 200 psi

One Port
90 degree



AC901

Two Ports



AC902

Three Ports



AC913

Part #	Description	Retail
AC901	(1) 3/8"-24 Male Inlet to (1) 3/8"-24 Female Outlet	41.00
AC902	(1) 3/8"-24 Male Inlet to (2) 3/8"-24 Female Outlets	
AC913	(1) 3/8"-24 Male Inlet to (3) 3/8"-24 Female Outlets	
AK901	Service Kit for AC901, AC902 & AC913	8.00

HP Port Adapters

- Reroute, or increase, the number of high pressure hoses coming off your first stage
- Chromed brass construction with Viton O-rings
- High pressure only – maximum 5000 psi
- Cleaned for use with up to 40% pre-blended Nitrox

AC906



HP Splitter

- (1) 7/16"-20 male inlet to (2) 7/16"-20 female outlets
- Use this to add an additional high pressure port to your regulator's first stage

AC907



HP Swivel

- (1) 7/16"-20 male inlet to (1) 7/16"-20 female outlet
- Use this to route your HP hose 90°

AC908



HP Extender

- (1) 7/16"-20 male inlet to (1) 7/16"-20 female Outlet
- The extender is useful if there is not enough room on the regulator's first stage for your computer transmitter

Part #	Description	Retail
AC906	HP Splitter - (1) 7/16"-20 Male Inlet to (2) 7/16"-20 Female Outlets	80.00
AC907	HP Swivel - (1) 7/16"-20 Male Inlet to (1) 7/16"-20 Female Outlet	43.00
AC908	HP Extender - (1) 7/16"-20 Male Inlet to (1) 7/16"-20 Female Outlet	23.00
AK906	Service Kit for AC906	8.00
AK907	Service Kit for AC907	8.00

1/4" NPT Adapters

- Converting your regulator / hoses to 1/4" NPT has many practical applications in diving as well as your garage or shop
- Used with surface supplied umbilicals, switch blocks, comm gear and pneumatic tools
- Viton O-rings where applicable
- Models made of brass are for low pressure only - below 200 psi

AC905



AC915



AC916



AC917



AC923



Part #	Description	Material	Retail
AC905	1/4" NPT Male to 9/16"-18 Male	Stainless	34.00
AC915	1/4" NPT Male to 3/8"-24 UNF Female	Stainless	34.00
AC916	1/4" NPT Male to 3/8"-24 UNF Male	Brass	13.50
AC917	1/4" NPT Male to 3/8"-24 UNF Female	Brass	13.50
AC923	1/4" NPT Female to 3/8"-24 UNF Male	Brass	13.50

HP Hose QD Adapter

- Add to any pressure gauge, console or air integrated console which uses a standard high pressure hose
- Remove your gauges for safe storage
- Bayonet mount style quick-connect (push in and turn)
- Gauge attachment end has 7/16"-20 female threads
- Hose attachment end has 7/16"-20 male threads
- Airspool with Viton O-rings included
- Brass construction with black chrome finish
- Cleaned for use with up to 40% pre-blended Nitrox
- Max. operating pressure of 3500 psi (240 bar)



Part #	Description	Retail
AC383	High Pressure Hose Quick-Disconnect Adapter	104.00
AC384	High Pressure Hose Quick-Disconnect Adapter - Male Only	42.00
AK383	Service Kit for AC383	14.00

Easy Gripper

- Make your QD coupler easier to operate
- Helps when wearing thick gloves
- Wide, easy to grip collar
- Flat side to prevent clearance issues
- Fits over most standard scuba quick-disconnect hose ends
- Not for use on XS Scuba's Easy Grip Wide Collar QD Hoses



Part #	Description	Retail
AC155	Easy Hose Gripper	4.00

Poseidon Hose Adapter

- Convert any standard regulator hose to fit a Poseidon X-Stream second stage
- Fits any Poseidon second stage with M31-1.5 mm inlet threads
- Brass construction with black chrome finish
- Does not have a built-in relief valve
- Low pressure use only - below 200 psi



Part #	Description	Retail
AC980	Poseidon Hose Adapter	42.00

AGA 90° Hose Adapter

The AGA 90° Hose Adapter allows you to add a standard regulator hose to your AGA Divator Full Face Mask.

- Installs between standard regulator hose and the AGA Divator
- Chrome over brass construction with Viton O-rings
- 9/16"-18 male fitting to AGA M16-1.0 female fitting



Part #	Description	Retail
AC985	AGA 90° Hose Adapter	52.00

2nd Stage Plug Set

- Protect the end of your second stage and hose when the second stage is disconnected from the hose
- Includes both male and female plugs
- Machined Delrin construction
- Not to be used under pressure



Part #	Description	Retail
AC914	2nd Stage Plug Set	16.50



Used with permission by info@divethecave.com

Faber

Steel Cylinders

Hot Dip Galvanized

HDG is the most durable, corrosion-free exterior finish possible. The HDG process involves submerging the cylinder into molten zinc. The zinc metallurgically bonds to the steel so that it won't come off.

- 3442 psi (237 bar) working pressure
- Phosphatized-cleaned interior
- DOT SP13488 and TC SU7694-237
- O2 cleaned for use with up to 40% pre-blended Nitrox
- Includes self-draining tank boot with round rim
- Inlet thread is standard 3/4"-14 NPSM

VALVE OPTIONS FOR STEEL

With XS Scuba PVD PRO Valve
With XS Scuba PRO Valve
With Thermo DIN Valve
With Thermo Modular Valve
With XS Scuba Modular Valve
No Valve
No Boot

THERMO

VA200

INCLUDES PRO Valve

Part #	HP80-HDG	HP100-HDG	HP120-HDG	HP117-HDG	HP133-HDG
Retail	380.00	480.00	490.00	525.00	555.00

Gun Metal Gray

This triple-protected finish provides long-lasting durability. The process includes a zinc galvanizing spray, followed by an epoxy paint and then a top coat of polyurethane. The result is a beautiful cosmetic finish.

**In Sea Water with Valve*

Part #	HP80	HP100	HP120	HP117	HP133
Retail	350.00	450.00	460.00	495.00	525.00

Stated Volume	80 cu ft	100 cu ft	120 cu ft	117 cu ft	133 cu ft
True Capacity	81.7 cu ft / 10.2 liters	101.3 cu ft / 12.9 liters	120.1 cu ft / 15.3 liters	117.8 cu ft / 15 liters	133.5 cu ft / 17 liters
Service Pressure	3442 psi / 237 bar	3442 psi / 237 bar	3442 psi / 237 bar	3442 psi / 237 bar	3442 psi / 237 bar
*Buoyancy Full	-8.05 lbs / -3.65 kg	-8.41 lbs / -3.81 kg	-8.82 lbs / -4.00 kg	-9.12 lbs / -4.13 kg	-9.08 lbs / -4.12 kg
*Buoyancy Empty	-1.74 lbs / -0.79	-0.59 lbs / -0.15	0.65 lbs / 0.29	0.35 lbs / 0.16	1.45 lbs / 0.66
Weight Empty	28.3 lbs / 13.0 kg	34.0 lbs / 15.6 kg	39.2 lbs / 17.8 kg	37.6 lbs / 17.7 kg	42.4 lbs / 19.4 kg
Outside Diameter	7.25 in / 184 mm	7.25 in / 184 mm	7.25 in / 184 mm	8.00 in / 203 mm	8.00 in / 203 mm
Length	20.8 in / 53.0 cm	25.3 in / 64.5 cm	29.1 in / 74.5 cm	24.2 in / 61.5 cm	26.85 in / 68.0 cm
REE	68 cc	86 cc	100 cc	100 cc	113 cc

HYDRO DATES ON NEW FABER STEEL CYLINDERS

We ship cylinders with the "freshest" possible hydro date. We are limited in some models because of high manufacturing quantities and relatively low sales volume. Please understand, that steel cylinders shipped to your location within 18 months from date of manufacture are considered "current hydro" and not subject to further discounts.

OXYGEN USE WITH FABER STEEL CYLINDERS

Faber steel cylinders are cleaned at the factory for oxygen-enriched service up to 40% pre-blended Nitrox. If you intend to use this cylinder for oxygen-enriched service, it is the responsibility of the cylinder user to insure that the cylinder and all components are maintained in a proper state of oxygen cleanliness in strict accordance with regulatory requirements and industry standards.

Faber **Twin Steel Cylinders Sets**

Twin sets come complete with your choice of isolation manifold, stainless steel bands with hardware, and self-draining tank boots.

Faber Steel Cylinders

- 5 HP models available: 80, 100, 120, 117 or 133
- Gun Metal Gray finish or Hot Dip Galvanized
- DOT & TC approved
- Includes self-draining tank boots

Isolation Manifold

- Choose dedicated DIN outlets or PRO outlets with spin-out DIN inserts

Highland Steel Bands

- 304 stainless with all hardware included
- All bands are 2.5" wide

Gun Metal Gray



Hot Dip Galvanized



Gun Metal Gray

This triple-protected finish provides long-lasting durability. The process includes a zinc galvanizing spray, followed by an epoxy paint and then a top coat of polyurethane. The result is a beautiful cosmetic finish.

Hot Dip Galvanized

HDG is the most durable, corrosion-free exterior finish possible. The HDG process involves submerging the cylinder into molten zinc. The zinc metallurgically bonds to the steel so that it won't wear off.

Description	Thermo PRO Manifold Part #	Thermo DIN Manifold Part #	Retail
Twin HP80	TT80-200	TT80-300	1,160.00
Twin HP100	TT100-200	TT100-300	1,385.00
Twin HP120	TT120-200	TT120-300	1,400.00
Twin HP117	TT117-200	TT117-300	1,500.00
Twin HP133	TT133-200	TT133-300	1,550.00
Description	XS Scuba PRO Manifold Part #		Retail
Twin HP80	TX80-200		1,170.00
Twin HP100	TX100-200		1,395.00
Twin HP120	TX120-200		1,410.00
Twin HP117	TX117-200		1,510.00
Twin HP133	TX133-200		1,560.00

Description	Thermo PRO Manifold Part #	Thermo DIN Manifold Part #	Retail
Twin HP80	TT80-200-HDG	TT80-300-HDG	1,220.00
Twin HP100	TT100-200-HDG	TT100-300-HDG	1,445.00
Twin HP120	TT120-200-HDG	TT120-300-HDG	1,460.00
Twin HP117	TT117-200-HDG	TT117-300-HDG	1,560.00
Twin HP133	TT133-200-HDG	TT133-300-HDG	1,610.00
Description	XS Scuba PRO Manifold Part #		Retail
Twin HP80	TX80-200-HDG		1,230.00
Twin HP100	TX100-200-HDG		1,455.00
Twin HP120	TX120-200-HDG		1,470.00
Twin HP117	TX117-200-HDG		1,570.00
Twin HP133	TX133-200-HDG		1,620.00



Aluminum Cylinders

FINISH OPTIONS (AL06-AL40)

BNC Brushed No Coat

YL Yellow

VALVE OPTIONS FOR ALUMINUM

Change to XS Scuba K Valve

Change to XS Scuba PRO Valve

Change to XS Scuba PVD PRO Valve

Change to XS Scuba Modular Valve

Change to Thermo PRO Valve

Change to Thermo DIN Valve

Change to Thermo Modular Valve

No Valve

3000 psi Aluminum
Includes Thermo K



VA100-30A

THERMO

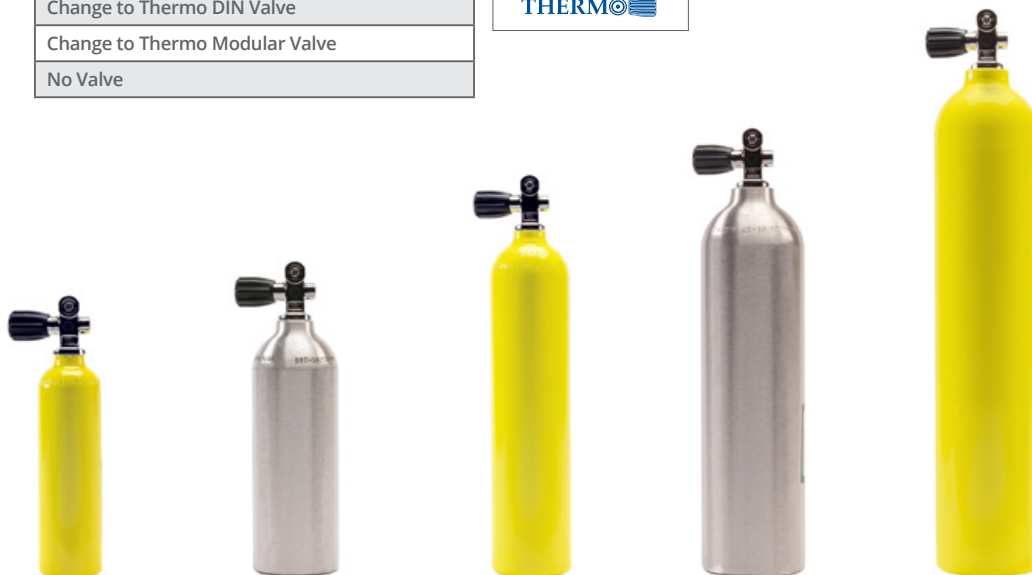

Part #	AL06	AL13	AL19	AL30	AL40
Volume	6 cu ft	13 cu ft	19 cu ft	30 cu ft	40 cu ft
Finish Options	BNC YL	BNC YL	BNC YL	BNC YL	BNC YL
Valve Included	Thermo K Valve	Thermo K Valve	Thermo K Valve	Thermo K Valve	Thermo K Valve
Service Pressure	3000 psi / 207 bar	3000 psi / 207 bar	3000 psi / 207 bar	3000 psi / 207 bar	3000 psi / 207 bar
True Capacity	5.8 cu ft / 0.8 liters	13.2 cu ft / 1.9 liters	19.9 cu ft / 2.9 liters	30.0 cu ft / 4.3 liters	40.0 cu ft / 5.7 liters
**Buoyancy Full	-1.4 lbs / -0.63 kg	-1.8 lbs / -0.8 kg	-1.3 lbs / -0.6 kg	-1.5 lbs / -0.68 kg	-0.7 lbs / -0.32 kg
**Buoyancy @ 500 psi	-1.0 lbs / -0.45 kg	-0.9 lbs / -0.4 kg	-0.1 lbs / -0.05 kg	0 lbs / 0 kg	2.5 lbs / 1.13 kg
Empty Weight (No Valve)	2.5 lbs / 1.2 kg	6.0 lbs / 2.7 kg	8.0 lbs / 3.6 kg	12.3 lbs / 5.6 kg	15.3 lbs / 6.9 kg
Outside Diameter	3.2 in / 81 mm	4.4 in / 111 mm	4.4 in / 112 mm	5.25 in / 133 mm	5.25 in / 133 mm
Cylinder Length (No Valve)	11.1 in / 283 mm	13.1 in / 333 mm	18.6 in / 472 mm	19.3 in / 490 mm	24.6 in / 625 mm

** In Sea Water with Valve

OXYGEN USE

Thunderbird cylinders are cleaned for oxygen and oxygen-enriched service at the factory. If you intend to use this cylinder for oxygen or oxygen-enriched service (ie. with any gas containing oxygen concentrations of 23.5% or more), all components used with the cylinder must be oxygen compatible. It is the responsibility of the cylinder user to ensure that the cylinder and all components are maintained in a proper state of oxygen cleanliness in strict accordance with regulatory requirements and industry standards.

HYDRO DATES ON NEW ALUMINUM CYLINDERS

We ship cylinders with the "freshest" possible hydro date. We are limited in some models/colors because of high manufacturing quantities and relatively low sales volume. Please understand that aluminum cylinders shipped to your location within 12 months of manufacture date are considered "current hydro" and not subject to discounts.

FINISH OPTIONS (AL50-AL100)

BNC Brushed No Coat

SB Shot Blast

NF Natural Finish

BK Black

BU Blue

GN Green

PR Purple

RD Red

WH White

YL Yellow

YL* Yellow (AL50 only)

**Aluminum Cylinders****VALVE OPTIONS FOR ALUMINUM**

Change to XS Scuba K Valve

Change to XS Scuba PRO Valve

Change to XS Scuba PVD PRO Valve

Change to XS Scuba Modular Valve

Change to Thermo PRO Valve

Change to Thermo DIN Valve

Change to Thermo Modular Valve

No Valve

3000 psi Aluminum
Includes Thermo K

VA100-30A

THERMO

3300 psi Aluminum
Includes Thermo PRO

VA200-33N

THERMO



Part #	AL50	AL63	AL80	ALN80	AL100
Volume	50 cu ft	63 cu ft	80 cu ft	80 cu ft	100 cu ft
Finish Options	NF YL*	BK BU BNC NF YL	BK BNC BU GN NF PR RD SB WH YL	BNC	BK BNC YL
Valve Included	Thermo K Valve	Thermo K Valve	Thermo K Valve	Thermo PRO Valve	Thermo PRO Valve
Service Pressure	3000 psi / 207 bar	3000 psi / 207 bar	3000 psi / 207 bar	3300 psi / 228 bar	3300 psi / 228 bar
True Capacity	48.4 cu ft / 6.9 liters	63.0 cu ft / 9.0 liters	77.4 cu ft / 11.1 liters	77.4 cu ft / 10.3 liters	98.8 cu ft / 13.2 liters
**Buoyancy Full	-2.5 lbs / -1.13 kg	-2.4 lbs / -1.1 kg	-1.7 lbs / -0.8 kg	-5.86 lbs / -2.59 kg	-4.6 lbs / -2.1 kg
**Buoyancy @ 500 psi	0.8 lbs / 0.36 kg	1.7 lbs / 0.77 kg	3.4 lbs / 1.54 kg	-0.9 lbs / 0.4 kg	1.9 lbs / 0.86 kg
Empty Weight (No Valve)	21.3 lbs / 9.7 kg	26.9 lbs / 12.2 kg	31.5 lbs / 14.3 kg	35.4 lbs / 16 kg	41.1 lbs / 18.6 kg
Outside Diameter	6.9 in / 175 mm	7.25 in / 184 mm	7.25 in / 184 mm	7.25 in / 184 mm	8.0 in / 203 mm
Cylinder Length (No Valve)	19.0 in / 483 mm	21.9 in / 555 mm	26.1 in / 662 mm	25.8 in / 655 mm	26.2 in / 665 mm

As you prepare to descend on your next challenging adventure, the last thing you want to have to think about are your cylinder valves. That is why technical and extreme divers around the globe rely on Thermo and XS Scuba branded valves and manifolds, the two names in valves that are synonymous with quality.

Don't compromise. Dive with the best there is!



What's In Your Cylinder?

Because Your Valve Makes The Difference!

Go with the most trusted, best-selling valves in the industry.



FEATURES OF XS SCUBA AND THERMO VALVES	XS Scuba	Thermo
One-piece safety assembly protected within the valve body	●	●
Dip tube tightens with hex wrench to avoid damage from pliers	●	●
Three outlets available: Deluxe K, PRO & DIN	●	●
High-pressure seat retainer is PTFE coated for smooth operation	●	●
100% factory tested, in water, to full working pressure	●	●
Meets the requirements of CGA V9-2009	●	●
Valve bonnet sealed with copper crush washer		●
Valve bonnet sealed with an O-ring	●	
Safety handwheel - See at a glance whether the valve is open	●	
Fully on to fully off with 1.5 turns of the handwheel	●	

Licensed Technology under U.S. Patent 8,191,574

XSCUBA SAFETY HANDWHEEL

100% Red



50% Red
50% Green



100% Green



Legend: The valve products on the following pages are designated as



=

*** WARNING*** COMPRESSED AIR ONLY

Never use this product with any gas in which the concentration of oxygen exceeds 21%. Failure to follow this warning may result in fire, explosion, injury and / or death.



=

*** WARNING*** MAXIMUM 40% OXYGEN PREMIXED

Never use this product with any gas in which the concentration of oxygen exceeds 40%. Failure to follow this warning may result in fire, explosion, injury and/or death.

XS SCUBA Deluxe K Valve

- Standard yoke outlet
- 3/4"-14 NPSM standard inlet threads
- Air service only
- 1.5 handwheel rotations from fully on to fully off

 SAFETY HANDWHEEL



Part #	Primarily Used For	Service Pressure	Retail
VX100-30A-VI	Aluminum Cylinders	3000 psi	85.00
VKX-K	XS Scuba K Valve Service Kit		13.00

XS SCUBA PRO Valve

- Standard yoke outlet with spin-out DIN insert converts to 230 bar DIN outlet
- 3/4"-14 NPSM standard inlet threads
- Clean for pre-blended Nitrox up to 40% oxygen
- 1.5 handwheel rotations from fully on to fully off

 SAFETY HANDWHEEL



Part #	Primarily Used For	Service Pressure	Retail
VX200-30N-VI	Aluminum Cylinders	3000 psi	95.00
VX200-33N-VI	Aluminum 3300 psi Cylinders	3300 psi	
VX200-34N-VI	HP Steel Cylinders	3442 psi	
VKX-P	XS Scuba PRO Valve Service Kit		17.00

XS SCUBA PRO Valve 1/2"-14 NGT Threads

- Standard yoke outlet with spin-out DIN insert converts to 230 bar DIN outlet
- 1/2"-14 NGT (National Gas Thread) tapered inlet threads
- Seals to cylinder with PTFE tape, not an O-ring
- Clean for pre-blended Nitrox up to 40% oxygen
- 1.5 handwheel rotations from fully on to fully off

 SAFETY HANDWHEEL



Part #	Primarily Used For	Service Pressure	Retail
VX250-22N-VI	Old 71.2 cu ft Steel Cylinders	2250 psi	115.00
VKX-P	XS Scuba PRO Valve Service Kit		17.00



EVERYTHING
FOR THE
PERFECT
DIVE



XS SCUBA PVD PRO Valve

- Mil-Spec black PVD finish
- Standard yoke outlet with spin-out DIN insert converts to 230 bar DIN outlet
- 3/4"-14 NPSM standard inlet threads
- Clean for pre-blended Nitrox up to 40% oxygen
- 1.5 handwheel rotations from fully on to fully off

 SAFETY HANDWHEEL

40% MAX
OXYGEN
PREMIXED



Removable
Spin-Out
DIN Insert
Included

Part #	Primarily Used For	Service Pressure	Retail
VX2PVD-30N-VI	Aluminum Cylinders	3000 psi	115.00
VX2PVD-34N-VI	HP Steel Cylinders	3442 psi	
VKX-P	XS Scuba PRO Valve Service Kit		17.00

XS SCUBA Modular PRO Valve

- Standard yoke outlet with spin-out DIN insert converts to 230 bar DIN outlet
- Modular access plug included
- 3/4"-14 NPSM standard inlet threads
- Clean for pre-blended Nitrox up to 40% oxygen
- 1.5 handwheel rotations from fully on to fully off

 SAFETY HANDWHEEL

40% MAX
OXYGEN
PREMIXED

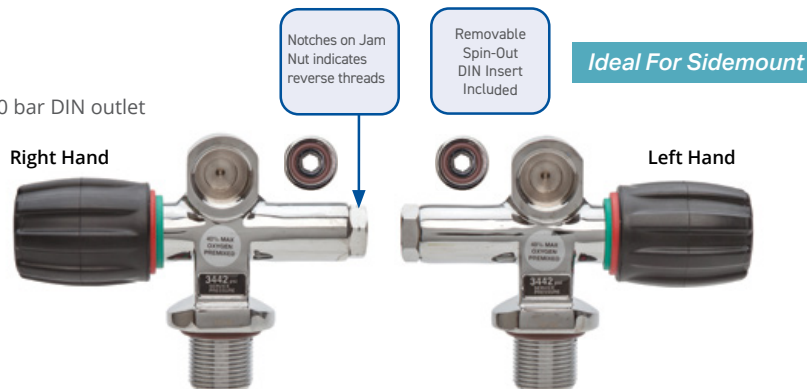

Part #	Orientation	Service Pressure	Retail
VX200L-30N-VI	Left Hand	3000 psi	105.00
VX200R-30N-VI	Right Hand	3000 psi	
VX200L-34N-VI	Left Hand	3442 psi	
VX200R-34N-VI	Right Hand	3442 psi	

XS SCUBA Crossbar with Isolator

- Connects right & left modular valves together to build a XS Scuba Isolation Manifold
- Center-to-center distance: 215 mm (8.46 in)
- Double barrel Viton O-ring seal
- Clean for pre-blended Nitrox up to 40% oxygen

 SAFETY HANDWHEEL

40% MAX
OXYGEN
PREMIXED



Part #	Description	Retail
VX0V0-N-VI	Crossbar with Isolator	125.00

XS SCUBA Isolation PRO Manifold

- PRO outlet, with spin-out insert, allows for DIN or yoke connection
- XS Scuba Safety Handwheel - know at a glance that your valve is 100% open
- 1.5 rotations of the handwheel from fully on to fully off
- Center-to-center distance: 215 mm (8.46 in) +/- 5 mm (0.2 in)
- 3/4"-14 NPSM standard inlet threads
- On/Off seat built from high strength brass with nylon seat and PTFE plated for years of smooth operation
- One-piece safety assembly protected within the body of the valve
- O-ring sealed bonnet
- Modular access plugs (R/L) included for use as single valves
- Screw-in dip tube with hex wrench tighten feature
- Meets the requirements of CGA V9-2009 standards

 SAFETY HANDWHEEL

40% MAX
OXYGEN
PREMIXED



Part #	Description	Service Pressure	Retail
VMX200-30N-VI	XS Scuba PRO Manifold	3000 psi	315.00
VMX200-34N-VI		3442 psi	
VKX-MF200	XS Scuba PRO Manifold Service Kit	-	54.00

THERMO Deluxe K Valve

Quality, dependability and reputation have made this valve the most popular, widely-used valve for scuba cylinders in the world. The Thermo K valve is used by more dealers, resorts and boat operators than any other valve. Trust the valve the professionals use.

- Standard yoke outlet
- 3/4"-14 NPSM standard inlet threads
- Air service only



Part #	Primarily Used For	Service Pressure	Retail
VA100-30A	Aluminum Cylinders	3000 psi	70.00
VKT-K	Thermo Deluxe K Valve Service Kit		13.00

THERMO PRO Valve

If you plan to use Nitrox (up to EAN40) or if you need to switch between yoke and DIN regulators, then the Thermo PRO valve is the valve for you. It is pre-cleaned and ready for any adventure.

- Standard yoke outlet with spin-out DIN insert converts to 230 bar DIN outlet
- 3/4"-14 NPSM standard inlet threads
- Clean for pre-blended Nitrox up to 40% oxygen



Removable Spin-Out DIN Insert Included

Part #	Primarily Used For	Service Pressure	Retail
VA200-24N	LP Steel Cylinders	2400 psi	80.00
VA200-30N	Aluminum Cylinders	3000 psi	
VA200-33N	Aluminum 3300 psi Cylinders	3300 psi	
VA200-34N	HP Steel Cylinders	3442 psi	
VKT-P	Thermo PRO Valve Service Kit		17.00

THERMO DIN Valve

The Thermo DIN valve is for those divers who use a dedicated 300 bar regulator on all their dives. This is the valve for those who go all DIN all the time.

- Dedicated 300 bar DIN outlet
- Attachment of DIN first stages only
- 3/4"-14 NPSM standard inlet threads
- Air service only



Part #	Primarily Used For	Service Pressure	Retail
VA300-30A	Aluminum Cylinders	3000 psi	90.00
VA300-34A	HP Steel Cylinders	3442 psi	
VKT-D	Thermo DIN Valve Service Kit		17.00

THERMO DIN Valve 7/8"-14 UNF Threads

- Set up for 3500 psi service for use on older "thin-necked" Pressed Steel 3500 psi cylinders
- May also be used on 4350 psi / 300 bar Luxfer 106 Composite Cylinders (must change safety assembly)
- 7/8"-14 UNF inlet threads
- Dedicated 300 bar DIN outlet
- Attachment of DIN first stages only
- Air service only



AIR
ONLY

Part #	Primarily Used For	Service Pressure	Retail
VA378-35A	Pressed Steel 3500 psi Cylinders	3500 psi	110.00
VKT-D	Thermo DIN Valve Service Kit		17.00

THERMO Modular PRO Valve

- Standard yoke outlet with spin-out DIN insert converts to 230 bar DIN outlet
- Modular access plug included
- 3/4"-14 NPSM standard inlet threads
- Clean for pre-blended Nitrox up to 40% oxygen

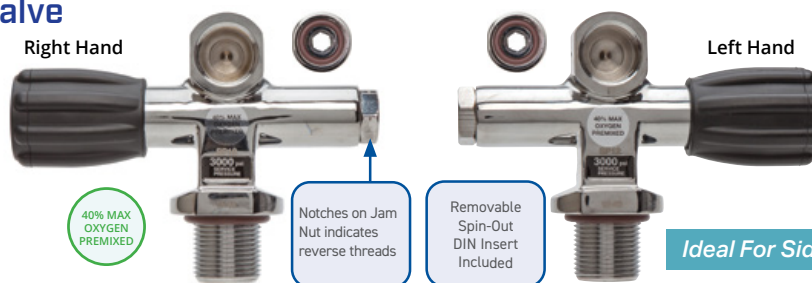

Part #	Orientation	Service Pressure	Retail
VA200L-30N	Left Hand	3000 psi	100.00
VA200R-30N	Right Hand	3000 psi	
VA200L-34N	Left Hand	3442 psi	
VA200R-34N	Right Hand	3442 psi	

THERMO Modular DIN Valve

- Dedicated 300 bar DIN outlet
- Attachment of DIN first stages only
- Modular access plug included
- 3/4"-14 NPSM standard inlet threads
- Air service only
- Great for sidemount

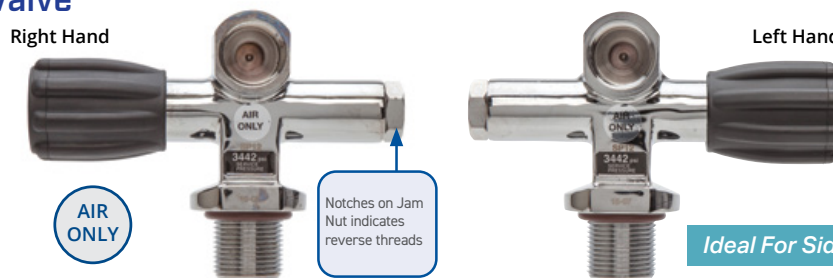

Part #	Orientation	Service Pressure	Retail
VA300L-30A	Left Hand	3000 psi	100.00
VA300R-30A	Right Hand	3000 psi	
VA300L-34A	Left Hand	3442 psi	
VA300R-34A	Right Hand	3442 psi	

THERMO Crossbar with Isolator

- Connects right & left modular valves together to build a Thermo Isolation Manifold
- Center-to-center distance: 215 mm (8.46 in)
- Double barrel O-ring seal
- Clean for pre-blended Nitrox up to 40% oxygen



Part #	Description	Retail
VC0V0-N	Crossbar with Isolator	104.00

THERMO Isolation Manifolds

PRO Manifold

- Your Choice of outlet
 - PRO - DIN/Yoke with removable spin-out insert
 - DIN - Dedicated 300 bar
- Center-to-center distance: 215 mm (8.46 in) +/- 5 mm (0.2 in)
- 3/4"-14 NPSM standard inlet threads
- High gas flow for optimum regulator performance
- On/Off seat built from high strength brass with nylon seat and PTFE plated for years of smooth operation
- One-piece safety assembly protected within the body of the valve
- Traditional copper crush washer sealed bonnet
- Modular access plugs (R/L) included for use as single valves
- Screw-in dip tube with hex tighten feature
- Meets the requirements of CGA V9-2009 standards



Part #	Description	Service Pressure	Retail
VMT200-30N	Thermo Isolation PRO Manifold	3000 psi	290.00
VMT200-34N		3442 psi	
VMT300-30A	Thermo Isolation DIN Manifold	3000 psi	
VMT300-34A		3442 psi	
VMT378-35A	Thermo DIN Manifold 7/8-UNF Inlet Threads	3500 psi	385.00
VKT-MF200	Isolation PRO Manifold Service Kit	-	54.00
VKT-MF300	Isolation DIN Manifold Service Kit	-	50.00

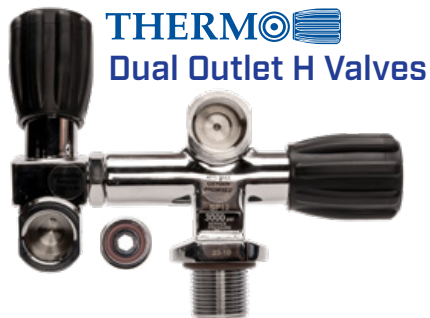

THERMO Dual Outlet H Valves

How to Build an H Valve

- Purchase a Thermo or XS Scuba modular valve
- Purchase a Thermo H adapter
- A right hand modular valve needs to be paired with a right hand H adapter and a left with a left
- The PRO/DIN outlets can be matched or mixed
- The modular access plug needs to be removed
- Note that the modular access plug and H adapter have reverse threads in the right hand version
- This photo is an example of a Thermo DIN outlet Left Hand Modular Valve (p/n VA300L-30N) paired with a Thermo PRO outlet Left Hand H Adapter (p/n VH200L-N)

THERMO PRO H Adapter

- Standard yoke outlet with spin-out DIN insert converts to 230 bar DIN outlet
- Attaches to all Thermo Modular valves
- Attaches to all XS Scuba Modular valves
- Right hand H adapter attaches to right hand modular valve
- Left hand H adapter attaches to left hand modular valve
- Clean for pre-blended Nitrox up to 40% oxygen



Part #	Description	Orientation	Retail
VH200L-N	Thermo PRO H Adapter	Left	98.00
VH200R-N		Right	

THERMO Thermo J Valve

This is the same J-Reserve Valve that the military uses.

- The reserve is 600 +/- 100 psi
- Tough-as-nails, black PVD finish
- PRO Outlet - Remove the spin-out insert to convert from yoke to 230 bar DIN
- 3/4"-14 NPSM standard inlet threads
- Clean for pre-blended nitrox up to 40% O₂
- Activation pull rod sold separately, p/n AC200



Up For
Reserve

Down For
Fill

Reserve Lever
On Inboard Side

Part #	Description	Retail
VA2J-xxN	Thermo J Valve	455.00
VKT-J-MAIN	Service Kit - J Valve, Main Side	24.00
VKP-J	Service Kit - J Reserve Assembly	44.00

THERMO Thermo One-Piece Twin Manifold

This is the same one-piece twin manifold that the military uses.

- 8.46 in / 215 mm center-to-center distance
- Tough-as-nails, black PVD finish
- PRO Outlet - Remove the spin-out insert to convert from yoke to 230 bar DIN
- Optional J-Reserve ready
- 3/4"-14 NPSM standard inlet threads
- Clean for pre-blended nitrox up to 40% O₂
- Activation pull rod sold separately, p/n AC200

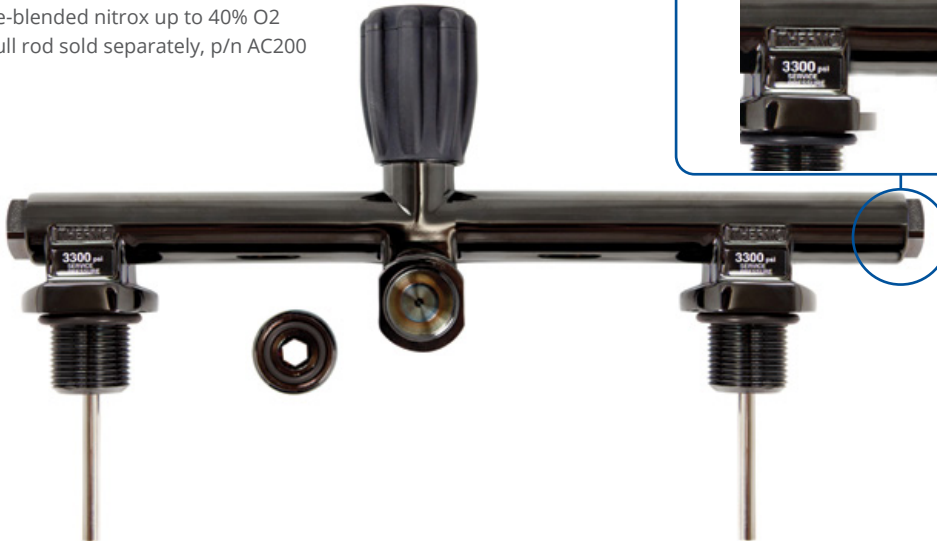

Optional Reserve "J" Valve

- Reserve activates at 600 psi +/- 100 psi
- Set lever up to hold reserve air
- Pull lever down to release reserve air
- Reserve lever operation is inboard between the diver and left side cylinder
- Optional pull rod available - sold separately

Up For
Reserve

Down For
Fill

Reserve Lever
On Inboard Side



Part #	Description	Retail
VMT500J-33N	Thermo One-Piece Manifold w/ J Reserve	799.50
VMT500-33N	Thermo One-Piece Manifold - No Reserve	699.50
VKT-1M	Service Kit - Manifold w/o J Reserve	25.00
VKP-J	Service Kit - J Reserve Assembly	44.00

Activation Pull Rod for J-Reserve Valve

- This 4.5 mm diameter pull rod fits most J-valves
- Made of strong, corrosion-resistant, 304 stainless steel
- Includes stainless steel tank band retaining clip



Part #	Description	Retail
AC200	Activation Pull Rod w/SS Tank Band Clip	34.00

Safety Assemblies



Part #	Description
VP01-20	Safety Assembly 2015 psi (3358 burst)
VP01-22	Safety Assembly 2250 psi (3750 burst)
VP01-24	Safety Assembly 2400 psi (4000 burst)
VP01-30	Safety Assembly 3000 psi (5000 burst)
VP01-33	Safety Assembly 3300 psi (5500 burst)
VP01-34	Safety Assembly 3442 psi (5250 burst)
VP01-43	Safety Assembly 4350 psi (7250 burst)

Outlet O-rings - K Valve



Part #	Description
VP02-B	Outlet O-ring - K Valve - Buna-N
VP02-V	Outlet O-ring - K Valve - Viton
VP02-P	Outlet O-ring - K Valve - Poly

Tank Neck O-rings



Part #	Description
VP03-B	Neck O-ring - Buna-N
VP03-V	Neck O-ring - Viton

Handwheels



Part #	Description
VP12-BK	Thermo Handwheel - Black
VP12-GN	Thermo Handwheel - Green

Service Kits

XS Scuba PRO Kit (shown)



Part #	Type	Description
VKX-K	XS Scuba	K Valve Service Kit
VKX-P		PRO Valve Service Kit
VKX-D		DIN Valve Service Kit
VKX-MF200		PRO & DIN Manifold Service Kit
VKT-K	Thermo	K Valve Service Kit
VKT-P		PRO Valve Service Kit
VKT-D		DIN Valve Service Kit
VKT-MF200		PRO Manifold Service Kit
VKT-MF300		DIN Manifold Service Kit

Outlet O-rings - PRO Valve



Part #	Description
VP15-V	Outlet O-ring - PRO Valve - Viton
VP15-P	Outlet O-ring - PRO Valve - Poly

DIN Insert - PRO Valve



Part #	Description
VP16-V	DIN Insert w/ Front & Back VP15-V O-rings

Seat and Stem



Part #	Description
VP05	Valve Seat
VP07	Valve Stem

Cylinder Boot

- High quality injection-molded construction
- Self-draining and durable
- Octagon rim design to prevent side rolling
- Round rim design for twins and boat racks



Round Rim



Octagon Rim

Part #	Fits	Diameter	Rim	Retail
TBX6A	Aluminum 50 & 72	6.90"	Octagon	18.00
TBX7A	Aluminum 63 & 80	7.25"	Octagon	13.00
TBR7A	Aluminum 63 & 80	7.25"	Round	15.00
TBX8A	Aluminum 100	8.00"	Octagon	22.00
TBR7F	Steel Faber	7.25"	Round	26.00
TBR8F	Steel Faber	8.00"	Round	26.00
TBX7S	Steel Worthington	7.25"	Octagon	30.00
TBX8S	Steel Worthington	8.00"	Octagon	30.00

Universal Valve Cap

- Fits Deluxe K and PRO valves
- Protect the valve outlet
- Nylon cord lanyard included - not attached



Part #	Description	Color	Retail
VC-BK	Universal Valve Cap	Black	2.50
VC-BU		Blue	
VC-GN		Green	
VC-PK		Pink	
VC-YL		Yellow	

Cylinder Net

- Protect your cylinder's paint and finish
- Reduce cylinder slippage
- Fits 7.25 to 8.00 in (184 to 203 mm) diameter cylinders
- Unique design follows the curvature at the top of the cylinder



Part #	Description	Color	Retail
TN-BK	Cylinder Net	Black	9.00
TN-BU		Blue	
TN-GN		Green	
TN-PK		Pink	
TN-YL		Yellow	



Stainless Steel DIN Plug

- Precision machined from 316 stainless steel
- Protects threads of 200 and 300 bar DIN threads
- Prevents gas loss from accidental turn on
- Includes Viton O-ring

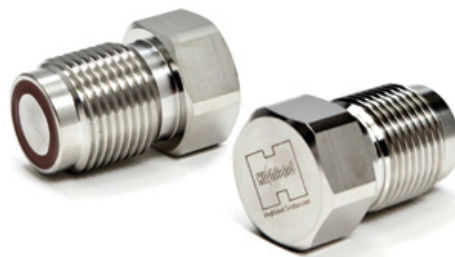

Part #	Description	Retail
HL402	Stainless Steel DIN Plug	24.00



Brass DIN Plug with Pressure Release

- Machined from marine brass
- In case the valve is accidentally turned on, the push button vent allows trapped gas to escape for easy plug removal



Part #	Description	Retail
HL422	Brass DIN Plug with Pressure Release	43.00
HK422	Service Kit for the HL422 DIN Plug	9.00

Plastic DIN Plug

- The economical way to protect your DIN valve threads and keep contaminants out
- Includes a safety relief plug in case gas is accidentally turned on while plug is installed
- Comes with cord attached



Part #	Description	Retail
AC210	DIN Plug with Attached Cord	6.00

DIN Fill Adapter

- Adapt DIN valves for filling with a standard yoke filler
- Fits all 200 and 300 bar DIN valves
- Rotating DIN handwheel
- Standard inlet and outlet O-rings (p/n VP15-V)
- Viton O-rings



ABOVE WATER USE ONLY

This adapter is designed to allow the filling of cylinders with 200 and 300 bar DIN valves from standard yoke fillers.

3442 PSI MAXIMUM

Part #	Description	Retail
AC375	DIN Filler Adapter	58.00

Scuba Tank Holder

Consists of a rugged, double slotted base with a removable, silicone band and stainless steel hook. The holder is designed to secure 7.25 in (184 mm) diameter scuba tanks. It can also fit 6.9 in (175 mm) and 8.0 in (203 mm) tanks, though the fit will not be as optimal.

- The silicone band can be mounted on either the left or the right side of the base so that you can pull it over your tank in either direction
- The bases are interlocking so you can connect as many together as needed
- Each base can be mounted directly to any hard surface using the six stainless steel screws (included) or using an optional aluminum rail

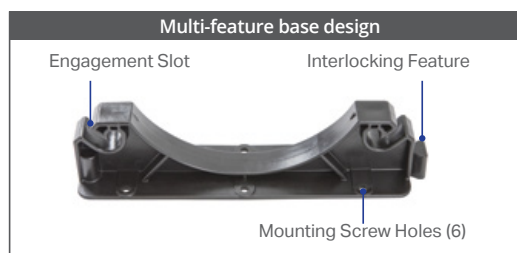
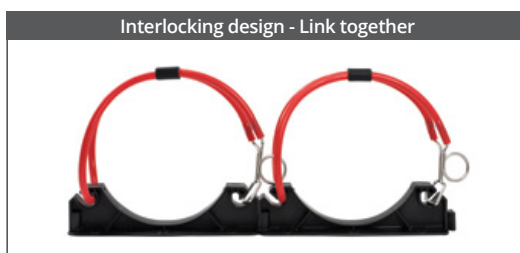

Part #	Description	Retail
TR120	Scuba Tank Holder	38.00

Extender/Replacement Band

Identical to the band assembly found in the TR120 above. It can be used as a replacement or an extender. Extenders are useful when a longer band is needed, such as to wrap around a cylinder with a BC on it. Add the Extender to the original band using one of the two methods shown below. Extenders are also easy to cut-to-size for custom applications.

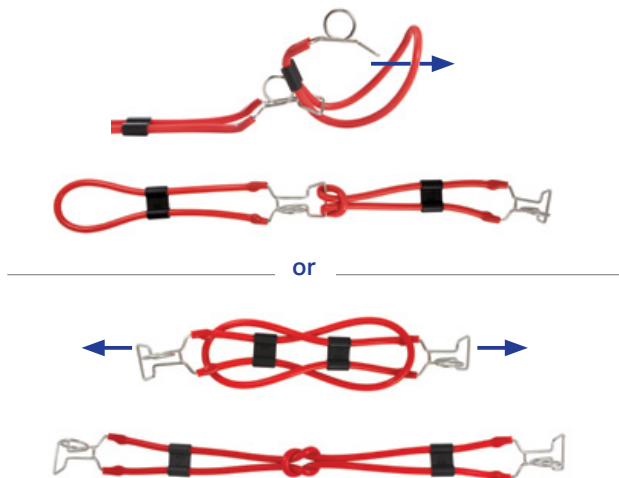

Secure a tank with BC attached

Part #	Description	Retail
TR160	Extender/Replacement Band	26.00

Tank Rail Kit

Aluminum Rails provide the best mounting option. By mounting to an aluminum rail, the tank holders can be easily slid in or out. The rail is 3-feet long, and can hold 3 tank holders.

- Each rail includes two end stoppers with thumb screws and stainless steel mounting screws
- Rails have a clear anodized coating to resist corrosion

Rail holds up to three Tank Holders



Tank Holders not included with kit

3 ft Rail (p/n TR200)



Part #	Description	Length	Retail
TR200	Tank Rail Kit	3 ft (Holds 3 Tanks)	94.00

Deluxe Tank Carrier with Shoulder Strap

- Fits 6.9 to 8.0 in (175 to 203 mm) diameter cylinders
- Hook-and-loop tank band straps with 2 in (50 mm) D-rings
- Rubber molded, side carry handle
- Removable, adjustable padded shoulder strap included



Part #	Description	Retail
AC240	Deluxe Tank Carrier	42.00

Steel Cylinder Carry Handle

- Carry steel tanks with ease and comfort
- Tough, injection-molded handle
- Folds down when not in use
- Fits Faber and Worthington steel cylinders



Part #	Description	Retail
AC440	Steel Cylinder Carry Handle	18.00

Pony Bottle Bag

- Connects to primary diving cylinder
- Utilizes BC tank straps
- Bottom strap adds stability to bag
- Self-draining mesh bottom
- Dual straps keep the pony bottle secure
- Designed to fit aluminum cylinders



BG406

BG413

BG419

Part #	Description	Fits	Diameter	Retail
BG406	Pony Bag - fits 6 cu ft aluminum cylinder	6 cu ft	3.2 in	17.00
BG413	Pony Bag - fits 13 cu ft aluminum cylinder	13 cu ft	4.4 in	20.00
BG419	Pony Bag - fits 19 cu ft aluminum cylinder	19 cu ft	4.4 in	24.00

Tank Banger

- Get your buddy's attention underwater
- Fits 6.9 to 8.0 in (175 to 203 mm) diameter cylinders
- Install around bottom of cylinder
- Color: neon green



Part #	Description	Retail
AC450	Tank Banger	8.00

Tank Stickers

- Durable vinyl material
- Easy to read design and layout
- Will not peel off in water with use



ST200



• Fits cylinders 5.25 to 8.0 in (133 to 203 mm) diameter

ST210



• Fits cylinders up to 5.4 in (137 mm) diameter

ST220



- Identify cylinders not being used for scuba diving purposes
- Ideal for paintball customers

ST230

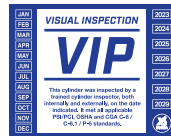

ST240



ST250



ST260

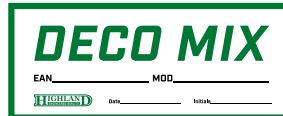

Part #	Description	Dimensions	Retail
ST200	Nitrox Sticker	25.5" x 6"	9.00
ST210	Nitrox Sticker - Pony Bottle	17" x 1.5"	6.00
ST220	Not for Scuba Sticker	25.5" x 6"	9.00
ST230	Visual Inspection Sticker	3.75" x 3"	-
ST240	Argon Sticker	17.5" x 3.5"	7.00
ST250	Oxygen Sticker	10" x 3"	6.00
ST260	Deco Mix Sticker	10" x 4"	7.00



Used with permission by info@divethecave.com



Twin Cylinder Bands



- Precision manufactured to the exact specifications of Joe McGrath's original Highland Millwork bands
- Deburred and polished edges to protect your cylinder paint/finish
- 18 gauge (.048 in) 304 grade stainless steel
- Band width is 2.5 in (64 mm)
- Polished fusion welds
- Polished #4 stainless steel finish
- The only choice of experienced technical divers
- Final finish completed by hand

INSTALLATION WARNING

If care is not taken during installation, you can gall (weld) a stainless steel nut onto a stainless steel bolt. You will then have to cut the bolt to remove it and replace the parts.

Below are instructions to help prevent galling during installation:

1. Clean the Bolts and Nuts

Start by cleaning the threads of bolts and nuts under warm running water. Scrub the threads with a toothbrush and mild detergent to break free any debris.

2. Use a Lubricant

You need to prevent the build up of heat when installing the nut to the bolt. Use a petroleum-based lubricant, like 3-In-One Oil on the threads. Apply the lubricant to the bolt threads ahead of the nut. Reapply more lubricant as needed.

3. Go Slow

Again, you need to prevent the build up of heat. Take your time. Slowly, thread the nut one full turn, then come back an 1/8 of a turn, wait and do it again. Spending an extra five minutes installing the nuts on to the bolts can prevent hours of headache hacksawing the bolts off and the expense of replacing the hardware.

REPLACEMENT BOLT KITS ARE NOT COVERED UNDER WARRANTY

Bolt Kit Specifications

BK725

2 pieces 3/8-16 x 5" hex head cap screws fully threaded 18-8 SS
2 pieces 3/8-16 wing nuts 18-8 SS
2 pieces 3/8-16 finish nuts 18-8 SS
2 pieces 3/8 medium split washer 18-8 SS
2 pieces 3/8 x 7/8 OD flat washer 18-8 SS

BK800

2 pieces 5/16-18 x 5.5" hex head cap screws fully threaded 18-8 SS
2 pieces 5/16-18 wing nuts 18-8 SS
2 pieces 5/16-18 finish nuts 18-8 SS
2 pieces 5/16 medium split washer 18-8 SS
2 pieces 5/16 x 3/4 OD flat washer 18-8 SS

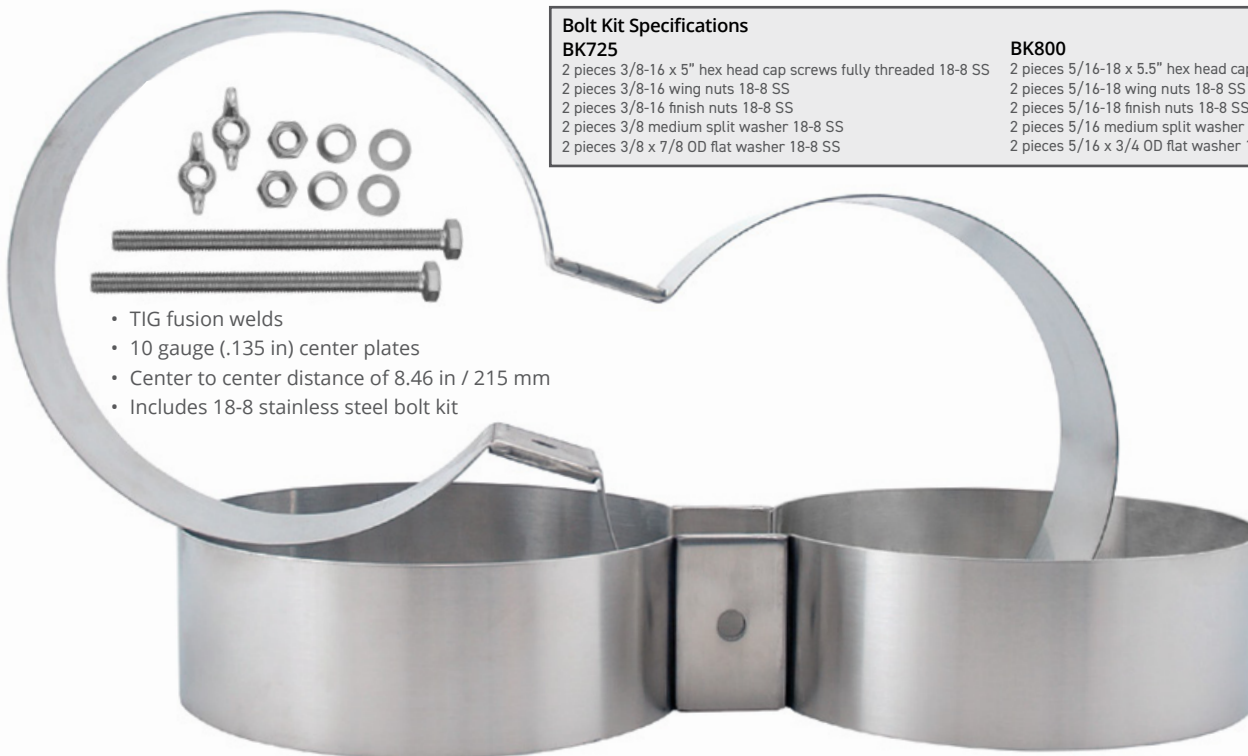

- TIG fusion welds
- 10 gauge (.135 in) center plates
- Center to center distance of 8.46 in / 215 mm
- Includes 18-8 stainless steel bolt kit

Part #	Description	Retail
SB725	7.25 in (184 mm) Diameter SS Bands	200.00
SB800	8.00 in (203 mm) Diameter SS Bands	210.00
BK725	3/8" Bolt Kit for SB725	25.00
BK800	5/16" Bolt Kit for SB800	25.00



Stage Bottle Strap Kits

Includes:

- 2 ea. 4 in (101 mm) jumbo stainless steel bolt snaps
- 1 in (25 mm) wide, adjustable length, nylon webbing handle
- 11 in (279 mm) piece of black tubing to create a comfortable carry handle
- Rugged, elastic EPDM hose retainer with easy grip tab
- Marine grade stainless steel cylinder clamp
- Nylon tube webbing to cover cylinder clamp
- 2 in (50 mm) piece of black PVC tubing to cover the cylinder band adjustment screw



3-bar slide allows for length adjustment

Part #	Description	Retail
SS440	Stage Bottle Strap Kit for 4.4 in diameter cylinders	74.00
SS525	Stage Bottle Strap Kit for 5.125 to 6.0 in diameter cylinders	
SS725	Stage Bottle Strap Kit for 6.5 to 8.0 in diameter cylinders	
SS440-CP	Replacement SS Clamp - 4.40 in with tube webbing and screw cover	14.00
SS440-HR	Replacement Hose Retainer - 4.40 in	12.00
SS525-CP	Replacement SS clamp - 5.125 to 6.0 in with tube webbing & screw cover	14.00
SS525-HR	Replacement Hose Retainer - 5.125 to 6.0 in	12.00
SS725-CP	Replacement SS clamp - 6.5 to 8.0 in with tube webbing & screw cover	14.00
SS725-HR	Replacement Hose Retainer - 6.5 to 8.0 in	12.00



Pony Mount

The band can be rotated in the bracket so that the buckle may be positioned on the left or right side

Designed for 7.25 in (184 mm) diameter primary cylinder

HL409 - Designed for 4.4 in (112 mm) diameter pony cylinders Aluminum 8, 13, & 19 cu ft

HL412 - Designed for 3.2 in (81 mm) diameter pony cylinders Aluminum 6 cu ft

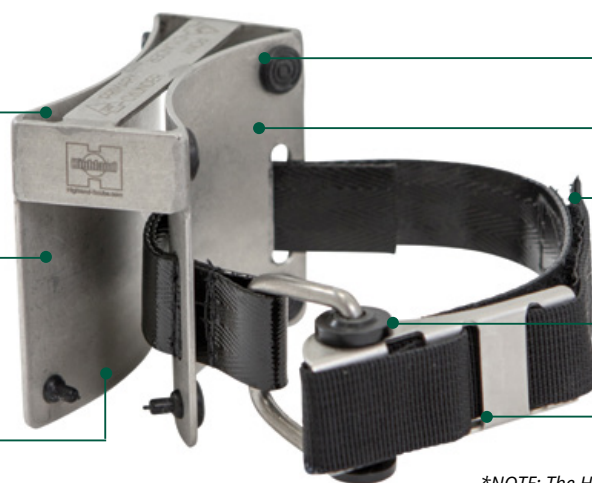

Rubber bumpers to protect paint

316 grade stainless steel construction

Adjustable length nylon webbing

Roller wheels make it easier to cam over the buckle and provide protection to the cylinder paint

Stainless steel cam buckle

**NOTE: The HL412 does not have the option of rotating the band in the bracket. The buckle is in a fixed position.*

Easy Mounting of the Pony Cylinder

- Mount on the diver's right or left side
- Mount upright or upside-down
- Secure and stable attachment
- Easy attachment with stainless steel cam buckle
- No hose clamps



Easy Attachment to the Primary Cylinder

- Uses your BC cam strap for attachment
- Designed for 7.25 in (184 mm) diameter primary cylinders
- Rubber bumpers to protect your cylinder's paint and finish



Part #	Description	Fits Sizes	Retail
HL409	Pony Mount for 4.4 in (112 mm) Diameter Cylinders	8, 13 & 19 cu ft	130.00
HL412	Pony Mount for 3.2 in (81 mm) Diameter Cylinders	6 cu ft	125.00
HL409-RB	Replacement Rubber Bumper	-	1.50
HL409-SA	Replacement Strap Assembly for HL409	-	42.00



SS Cylinder Clamps with Sleeves

- 3 sizes are available
- Covers most scuba cylinder diameters
- Made from 304 stainless steel
- Protector sleeves are sized for most popular cylinder diameters



Part #	Description	Fits	Diameter	Retail
HL620	Stainless Steel Cylinder Clamp with Sleeve	AL13, AL19	Up to 4.9 in (125 mm)	11.00
HL621		AL30, AL40	5.0-5.9 in (127-150 mm)	12.00
HL623		AL80, HP80, HP100, HP120	7.0-7.9 in (178-200 mm)	14.00



Voyager 60 Roller Duffel

Don't be fooled by the good looks! The Voyager 60 is, above all else, a dive bag. Divers don't just roll on slick airport floors, we walk on docks, climb over rocks, roll through dirt. We subject our bags to salt and sand. This is exactly why you want the Voyager 60. The all-terrain wheels, coupled with backpack straps and five handles, gets your bag to your dive destination with ease. The Voyager 60 will not rust and can be hosed out after each outing.

- Clever, double-duty external cinch straps
 - Travel with peace of mind knowing that external cinch straps ensure your bag won't bust open, no matter how rough the luggage handlers get
 - External cinch straps unclip, get repositioned, and become backpack straps
- All-terrain wheels take on all kinds of surfaces and can even be replaced
- Internal fin straps keep fins straight, along the bag's sidewalls
- A large, secondary compartment keeps clothes and towels separate from your dive gear
- An accessory pocket is handy for parts, tools and small items
- Weighs 8.7 lbs (3.9 kg)



Dimensions
29 x 16 x 13 in
74 x 41 x 33 cm

Internal compression straps keep items secure



The external security straps double as the backpack straps!



Part #	Description	Retail
BG180	Voyager 60 Roller Duffel	255.00

B3 Bomber Roller Duffel

It's a Big Black Bag. It's the B3 Bomber!

We realize that not everyone wants a fancy dive bag for exotic dive travel. Sometimes, you just want to get your gear across the parking lot. The B3 Bomber is an economy roller duffel that is up to the task.

- Large main compartment with 2 internal compression straps
- 2 large, external accessory pockets
- No inner liner for easy cleaning. Just hose it out
- Not logo'd up to draw attention to expensive scuba equipment inside
- Made from strong 1200D Magnum Coat fabric
- The trolley handle assembly is easily replaceable as it uses SS screws instead of rivets
- Weighs only 7.6 lbs (3.5 kg)!
- Main compartment capacity: 6032 cu in



Dimensions
29 x 16 x 13 in
74 x 41 x 33 cm

Part #	Description	Retail
BG145	B3 Bomber Roller Duffel	165.00
BG945	B3 Bomber Replacement Trolley Handle Assembly	46.00

Coastal CD

Add convenience and versatility to your next dive trip with a Coastal CD. In its collapsed form, it is a padded regulator bag, ideal for bringing your regulator and computer on the plane as a personal item, thereby reducing the weight of your checked bag. When you arrive at your destination, it expands into a mesh duffel, large enough to hold the remainder of your gear.

- Large enough to carry a complete set of scuba equipment
- Robust zippers are non-metallic and corrosion free
- The tough poly mesh, which allows the bag to ventilate and drain, is fade and snag resistant
- Mesh duffels are perfect for rinsing and drying your gear



Dimensions Opened
12 x 12 x 31 in
(30.5 x 30.5 x 78.7 cm)

Dimensions Closed
12 x 12 x 5 in
(30.5 x 30.5 x 13 cm)

Part #	Description	Retail
BG255	Coastal Convertible Duffel	90.00

Coastal Standard

- A nylon, self-repairing, #10 coil zipper, with two zipper pulls, runs down the center
- 2 in (50 mm) triangle rings on either end accommodate the optional XS Scuba shoulder strap (p/n BG915)
- Padded carry handle on top
- Large enough to carry a complete set of scuba gear



Dimensions
29 x 13 x 13 in
74 x 33 x 33 cm

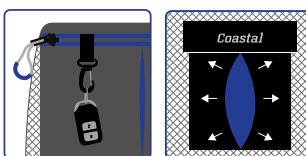

Dimensions
29 x 13 x 13 in
74 x 33 x 33 cm

Part #	Description	Retail
BG225	Coastal Standard	50.00
BG245	Coastal Pro	80.00

Coastal Roller

- Exclusive modular replaceable wheel assemblies
- Folds up to compact size for traveling
- Tough, polyester mesh with thick tarpaulin reinforcement
- Molded handle on one end
- Has a U-shaped opening for easy access to gear
- Large, pleated side pocket with accessory clip
- 2 in (50 mm) triangle rings on either end accommodate the optional XS Scuba shoulder strap (p/n BG915)

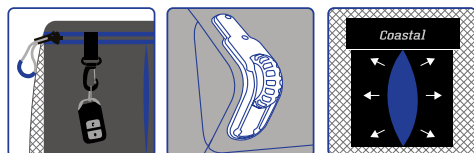

Dimensions
30 x 13 x 15 in
76 x 33 x 38 cm

Part #	Description	Retail
BG250	Coastal Roller	145.00



Seaside Pro

- Great for snorkeling adventures and beach outings
- Single, padded sling strap with attachment loop
- Tough polyester mesh with thick, tarpaulin bottom panel

Dimensions
12 x 24 in
30 x 60 cm

Part #	Description	Color	Retail
BG340BK	Seaside Pro	Black	50.00
BG340BU		Blue	
BG340PK		Pink	
BG340RD		Red	
BG340YL		Yellow	



Seaside Deluxe

- Holds a complete set of diving equipment
- Water resistant internal zippered pocket made of tarpaulin
- Expandable external pocket
- Tough polyester mesh with thick, tarpaulin bottom panel

Dimensions
15 x 28 in
38 x 71 cm

Part #	Description	Color	Retail
BG350BK	Seaside Deluxe	Black	85.00
BG350BU		Blue	
BG350PK		Pink	
BG350RD		Red	
BG350YL		Yellow	



Seaside Elite

- Holds a complete set of cold water gear
- Large, internal dry pocket with welded with welded seams that's great for clothing or a towel
- Expandable external pocket
- Side zipper runs the length of the bag for easy access to contents
- Tough polyester mesh with thick, tarpaulin bottom panel

Dimensions
17 x 30 in
43 x 76 cm

Part #	Description	Color	Retail
BG360BK	Seaside Elite	Black	120.00
BG360BU		Blue	
BG360PK		Pink	
BG360RD		Red	
BG360YL		Yellow	

Snorkeling Backpack

The XS Scuba Snorkeling Backpack is built-for-purpose. It is a convenient and compact way to transport your snorkeling gear to the beach or boat. The bungee cord and pleated pocket hold your additional items so that everything is secure in one place.

- Single sling strap, padded for comfort
- Internal, padded mask bag which allows you to keep your snorkel attached
- Fits fins up to 29 in (73.6 cm) in length
- Pleated accessory pocket with car key clip
- Bungee cord tie-downs secure your beach towel
- Side and bottom ventilation panels
- Includes a trial-size bottle of defog



Inside View

Internal,
padded mask
bag allows
you to keep
your snorkel
attached

Dimensions

8 dia. x 26 L in
20 dia. x 66 L cm

Part #	Description	Retail
BG331	Snorkeling Backpack	75.00

Mesh Fin Backpack

- Simple and economical mesh bag
- Nylon bottom with drain grommet
- Drawstring closure with cord lock
- Adjustable padded shoulder straps
- Nylon webbing loop for hanging
- Holds a pair of full size scuba fins, mask, snorkel and accessories



Front



Back

Dimensions

8 dia. x 26 in L
20 dia. x 66 cm L

Part #	Description	Retail
BG333	Mesh Fin Backpack	23.00

Leeward 6 Regulator Bag

- An internal zippered pocket is the perfect place to hold port plugs, hex keys, tie wraps and mouthpieces
- Hook-and-loop hold downs in opposite corners keep your regulator system stationary
- External D-rings are available for an optional shoulder strap (p/n BG915)
- Padded carry handle along top edge



Dimensions

14 x 10 x 4 in (560 cu in)
36 x 25 x 10 cm (9176 cc)

Part #	Description	Retail
BG706	Regulator Bag	50.00

Voyager 5 Regulator Bag

Protect your regulator and instruments with this fully-padded Voyager 5 Regulator Bag. This is a quick and easy way to pull your regulator system out of your large roller bag and carry it aboard the airplane.

- The circular shape is ideal for coiling your regulator hoses
- Inner diameter is a full 12 in (30 cm)
- Attached D-rings will accommodate an optional shoulder strap (p/n BG915)
- Carrying handle
- Self-repairing nylon coiling zipper with dual zipper pulls



Inside View

Dimensions

12 dia. x 4 in deep
30 dia. x 10 cm deep

Part #	Description	Retail
BG705	Voyager 5 Regulator Bag	44.00

The Landing Pad

Beach divers, we've heard your cry! You don't want to put wet, sandy wetsuits and boots in the trunk of your car or in your gear bag with your other gear. The Landing Pad is meant for you.

- Large 36 in (91 cm) diameter
- Stand on it while peeling off your wet, sandy boots and wetsuit
- Pull up on the two handles to cinch the pad around your legs
- Step out of it, fasten it, and throw it in the trunk
- The water, sand and mud stay contained in the Landing Pad



Comes in compact storage bag



Part #	Description	Retail
BG900	The Landing Pad	60.00

Protective Mask Wrap

- Protect your expensive mask
- Fully padded construction with plush interior
- Easy access, top opening with hook-and-loop strips
- Innovative design allows the snorkel to remain attached
- Mesh vent front panel for quick drying
- Side pocket to carry a bottle of defog
- Includes a trial-size bottle of defog

*Snorkel not included



Dimensions
8 x 5 x 3.5 in
20 x 13 x 9 cm

Part #	Color	Description	Retail
BG540BK	Black	Protective Mask Wrap	25.00
BG540DF	Dive Flag		

Weight Bag

This time-tested bag enjoys performing just one duty, and that is hauling lead. No bag does it better.

- Designed specifically for diving weights
- Can handle up to 60 lbs (27 kg) of lead weight
- The large, U-shaped zippered opening can accommodate most weight-integrated BC pockets
- The padded carry handle is easy on the hand



Dimensions
12 x 6 x 6 in
30 x 15 x 15 cm

Part #	Description	Retail
BG550	Weight Bag	44.00

Collection Bag

- High quality nylon mesh bag
- Nylon cord drawstring closure
- Designed for carrying small items
- Deluxe swivel clip for attachment to diver



Dimensions
12 x 9 in
30 x 23 cm

Part #	Description	Retail
BG570	Collection Bag	12.00

Hide-A-Way Bag

- Carry this bag on every dive
- Super compact until needed
- Large bag stuffs into small mesh pouch
- Nylon cord drawstring closure
- Deluxe swivel clip for attachment to diver



Dimensions
27 x 17 in
68 x 43 cm

Part #	Description	Retail
BG580	Hide-A-Way Bag	20.00



Shoulder Strap

- Adjustable and padded for comfort
- Easy to attach with heavy-duty snap clips
- Adjustable from 38 to 60 in (97 to 152 cm) length



Part #	Description	Retail
BG915	Adjustable Shoulder Strap	12.00

Inflatable Display Bladder for Bags

- Custom display bladders are the best way to properly display your Coastal Duffel Bags and Seaside bags



Dimensions
13 x 13 x 29 in
33 x 33 x 74 cm

Part #	Color	Description
BG930	Black	Inflatable Display Bladder for Bags





DARK WATER



Head to where the adventure is. Head to the Dark Water.

This Highland frameless mask features pure, ultra-clear glass, which eliminates the green tint found in normal mask glass. The buckles attach to the mask skirt, allowing the mask to fold into a flat package, making this an ideal spare mask to carry on your harness.

- Features pure, ultra-clear glass, which eliminates the green tint found in ordinary mask glass
- The buckles attach to the mask skirt, allowing the mask to fold into a flat package, making this an ideal back-up mask to stow in the Squall Pocket (p/n HL230)
- The split strap on the back prevents strap migration on the back of the head



Part #	Description	Retail
MAH400BS	Dark Water Mask	110.00



OUTER LIMITS



Let your next expedition lead you to the Outer Limits.

Ultra-clear, pure glass is a common feature with Highland frameless masks. The universal fit, coupled with the HD time-proven buckles, makes this the choice of serious divers.

- Features pure, ultra-clear glass, which eliminates the green tint found in ordinary mask glass
- The buckles attach to the mask skirt, allowing the mask to fold into a flat package, making this an ideal back-up mask to stow in the Squall Pocket (p/n HL230)
- Time-proven buckles are strong and hold the strap securely



Part #	Description	Retail
MAH405BS	Outer Limits Mask	110.00



SQUALL P O C K E T

The Squall Pocket is perfect for carrying your backup mask. The semi-rigid sides allow the mask to slide right in. An over-sized clip on the front is no match for 5 mm or dry gloves. The Squall is so versatile, it can also carry many types of technical accessories, such as spools, wet notes, and SMBs.

- Made from rugged 1680D nylon
- Tri-fold web loops clamp on to 2 in (50 mm) harness webbing
- A 1 in (25 mm) SS D-ring provides an alternate clip-on option
- Features an over-sized 2 in (50 mm) side-release buckle for easy operation with gloves



Internal Dimensions:
6.25 x 2 x 4 in
(15.9 x 5.1 x 10.2 cm)

External Dimensions:
7 x 2.5 x 5 in
(17.8 x 6.4 x 12.7 cm)

Part #	Description	Retail
HL230	Squall Pocket	45.00

Mikros

The Mikros Mask is an ultra-low volume freediving mask. This minimalistic, well-fitted mask incorporates all the latest in mask technology.

- Super lightweight due to its impact-resistant, polycarbonate lenses
- Unique, angled, side lenses expand the freediver's peripheral vision
- The lenses are UV400 and have an anti-scratch, anti-fog coating
- Folds down flat for compact storage
- Patented, quick-release, swivel buckles allow for easy installation, detachment, and adjustment
- A soft patch of silicone located on both sides of the nose pocket makes it easier to pinch your nose to equalize your ears during descent



Part #	Color	Description	Retail
MA520BS	Black	Mikros Mask	77.00
MA520BU	Blue		
MA520WH	White		

Crew Frameless

Frameless masks are made from the direct bonding of the silicone mask skirt to the tempered glass. By eliminating the thick plastic frame, the frameless masks are lighter, lower in volume, and more streamlined. As a class, they enjoy more popularity than ever before.

- Large single window for unobstructed view
- Easy-to-adjust ratcheting buckles
- Double, feather-edged sealing skirt
- Made of hypoallergenic silicone for comfort and longevity
- Includes mask storage box



Part #	Color	Description	Retail
MA405BS	Black Silicone	Crew Mask	82.00

Merge 3 Frameless

Frameless masks continue to surge in sales and popularity because they are lighter weight and so streamlined. Eliminating the mask frame allows the front lens to move closer to the face providing an excellent peripheral view. The Merge 3's popularity is due to its ability to fit so many faces.

- The buckles swivel for optimal fit and comfort
- The wide strap is comfortable and stays put on the back of the head
- Direct bonding of silicone to the tempered glass, thereby eliminating an external frame
- Made of hypoallergenic silicone for comfort and longevity
- The blue model is clear silicone with blue buckle plates
- Includes mask storage box



Part #	Color	Description	Retail
MA415BS	Black Silicone	Merge 3 Mask	73.00
MA415BU	Blue		

Stalker

The Stalker masks are a favorite among freedivers and spearos. This two lens mask is available in a stealthy all-black silicone.

- The all-black model features a unique lens coating which keeps fish from seeing the diver's eyes
- The matte finish of the silicone skirt prevents light reflection
- Stealth look blends into the environment
- The low volume prolongs the need for equalization and allows easy clearing
- The buckles are positioned directly on the skirt which minimizes weight and drag
- Includes mask storage box



CE

Part #	Color	Description	Retail
MA500BS	Black Silicone	Stalker Mask	82.00



Stalker Camo

The Stalker mask was introduced a few years ago and quickly gained popularity among freedivers and spearos. To provide more options to your spearo customers, we now offer three camouflage versions. Available in black camo, green camo and blue camo using the latest water transfer technology on the silicone mask skirts.



CE

Part #	Color	Description	Retail
MA500BS-CAMO	Black Camo	Stalker Camo Mask	82.00
MA500BU-CAMO	Blue Camo		
MA500GN-CAMO	Green Camo		

Fusion

Advanced technology allows side windows to be bonded directly to the front glass creating a panoramic view. While we can't have eyes on the back of our heads, this is the next best thing!

- Beveled and bonded tempered lenses
- Soft, supple silicone skirt
- Strong polycarbonate frame
- Includes mask storage box



Part #	Color	Description	Retail
MA100BK	Black	Fusion Mask	78.00
MA100BS	Black Silicone		
MA100BU	Blue		
MA100CL	Clear		
MA100YL	Yellow		

Fusion Purge

This mask is our popular Fusion Mask (above) with the addition of a purge valve in the nose pocket.

- Clear out the water with ease through the one-way purge valve
- Exhaled bubbles are kept out of field-of-view with patented skirt
- Includes mask storage box



Part #	Color	Description	Retail
MA150BK	Black	Fusion Mask with Purge	83.00
MA150BS	Black Silicone		
MA150BU	Blue		
MA150CL	Clear		
MA150YL	Yellow		

Fusion 3

A stylized version of the original Fusion Mask. Enjoy the same panoramic view provided by side windows. Glass to glass bonding eliminates the need for a support structure in the corners.

- Rotating, quick-connect buckles provide optimal head strap angle
- Beveled and bonded tempered lenses
- Includes mask storage box



Part #	Color	Description	Retail
MA120BI	Blue Ice*	Fusion 3 Mask	83.00
MA120BK	Carbon Black		
MA120BS/BI	Blk Sil / Blue Ice*		
MA120BS/BK	Blk Sil / Black		
MA120BS/RD	Blk Sil / Fire Red*		
MA120BS/WH	Blk Sil / White		
MA120BS/YL	Blk Sil / Yellow		
MA120BL	Blue		
MA120CL	Clear		
MA120YL	Yellow		

*Premium air-brushed color



Used with permission by info@divethecave.com

Diamond

Named for the tactile cross-cut accents on the upper corners of the frame, the Diamond Mask proves you don't have to spend a small fortune to get an exceptional mask.

- Advanced, "3D Fit" mask skirt provides the ultimate seal while preventing annoying mask "ride-up"
- Drop point lenses provide excellent downward visibility
- Rotating, quick-connect buckles provide optimal head strap angle
- Counter-posed buttons allow easy loosening of the strap, even with gloves



CE



Unique cross-cut accents on the frames give the Diamond Mask its name.

Part #	Color	Description	Retail
MA330TA	Transparent Aqua	Diamond Mask	78.00
MA330TP	Transparent Purple		

Gauge Reader *Down View Design*

What? Your arm is not long enough to read your gauges? Then you need a Gauge Reader Mask, the original slant-back, down view design.

- The unique glass to glass bond allows the +1.75 positive diopter lenses to slant back and downward, the ideal position for reading instrumentation, looking at camera settings or writing on slates
- Includes mask storage box



CE



Built-In Magnifier

Part #	Color	Description	Retail
MA290BS	Black Silicone	Gauge Reader Mask	106.00
MA290BU	Blue		
MA290CL	Clear		
MA290YL	Yellow		

Cortez

The Cortez Mask is unique in two ways. The skirt is wider from top to bottom providing an excellent fit on larger faces and it comes standard with a contoured X-Strap, which fits comfortably on the back of the head.

- A large lens gives this mask an incredible field of vision
- Comes standard with a center-pull X-Strap for comfort and ease of adjustment
- Includes a mask storage box



CE

Part #	Color	Description	Retail
MA420BK	Black	Cortez Mask	78.00
MA420BU	Blue		

Metro

Our popular Metro Mask assortment has grown with the addition of new black silicone models with bright frames. Metro Masks easily accommodate corrective lenses. We offer a wide selection of negative and positive diopters.

- This mask fits almost everyone
- Comfortable, silicone skirt
- Split window design
- Double feather edged sealing surface
- Durable polycarbonate frame
- Includes mask storage box



CE



Part #	Color	Description	Retail
MA605BS/BU	Black Silicone/ Blue	Metro Mask	50.00
MA605BS/OR	Black Silicone / Orange		
MA605BS/YL	Black Silicone / Yellow		
MA605BS/RD	Black Silicone / Red		
MA605BS/GN	Black Silicone / Green		
MA605BK	Black		
MA605BS/BK	Black Silicone / Black		
MA605BU	Blue		
MA605CL	Clear		
MA605YL	Yellow		

Corrective Mask Lenses

Part #	Diopter	Side	Part #	Diopter	Side	Part #	Diopter	Side
LS10L	-1.0	Left	LS35L	-3.5	Left	LS60L	-6.0	Left
LS10R	-1.0	Right	LS35R	-3.5	Right	LS60R	-6.0	Right
LS15L	-1.5	Left	LS40L	-4.0	Left	LS65L	-6.5	Left
LS15R	-1.5	Right	LS40R	-4.0	Right	LS65R	-6.5	Right
LS20L	-2.0	Left	LS45L	-4.5	Left	LS70L	-7.0	Left
LS20R	-2.0	Right	LS45R	-4.5	Right	LS70R	-7.0	Right
LS25L	-2.5	Left	LS50L	-5.0	Left	LS75L	-7.5	Left
LS25R	-2.5	Right	LS50R	-5.0	Right	LS75R	-7.5	Right
LS30L	-3.0	Left	LS55L	-5.5	Left	LS80L	-8.0	Left
LS30R	-3.0	Right	LS55R	-5.5	Right	LS80R	-8.0	Right



OD = Right Eye
OS = Left Eye

Negative Diopter

- Negative diopter covers entire surface of lens
- Easy to install on XS Scuba Metro & M-Line
- Fits many of today's most popular masks
- Precision ground and polished
- Tempered glass
- Meets ANSI Z86.11.1985 standards
- Available in -1.0 to -8.0 negative diopters

Positive Diopter

- Positive magnification covers bottom 1/3 of lens
- Top 2/3 of lens is clear glass
- Same features as negative lenses
- Available in +1.75, +2.25 & +2.75 positive diopters

Description								Retail
Negative Diopter - Single Lens								27.00
Part #	Diopter	Side	Part #	Diopter	Side	Part #	Diopter	Side
LSP175L	+1.75	Left	LSP225L	+2.25	Left	LSP275L	+2.75	Left
LSP175R	+1.75	Right	LSP225R	+2.25	Right	LSP275R	+2.75	Right
Description								Retail
Positive Diopter - Single Lens								30.00

Fusion 2 Jr.

- Perfect mask for smaller and narrow faces
- Fusion 2 mask reduced in size by 15%
- Comfortable, crystal silicone skirt
- Four window design
- Includes mask storage box



CE

Part #	Color	Description	Retail
MA220BK	Black	Fusion 2 Jr. Mask	67.00
MA220BU	Blue		
MA220CL	Clear		
MA220YL	Yellow		

Goby

- Perfect for kids and smaller faces
- Comfortable, crystal silicone skirt
- Double feather edged sealing surface
- Durable polycarbonate frame with tempered glass lenses
- Includes mask storage box



CE

Part #	Color	Description	Retail
MA700BU	Blue	Goby Mask	48.00
MA700YL	Yellow		

Neoprene Mask Strap Pads

Go easy on your hair while adding comfort to your dive.

- Easy addition to most masks
- No need to remove original strap as the hook-and-loop opening along one side allows insertion of the original strap
- Soft 2 mm neoprene



Dive Flag



Blue Hibiscus



Rayas del Mar

Part #	Description	Design	Retail
AC160BH	Mask Strap Pads	Blue Hibiscus	14.00
AC160DF		Dive Flag	
AC160RM		Rayas del Mar	

Silicone Mask Strap - Replacement

- Fits most masks
- Injection-molded from liquid silicone
- Length 22.5 in (57 cm)
- Split headstrap design

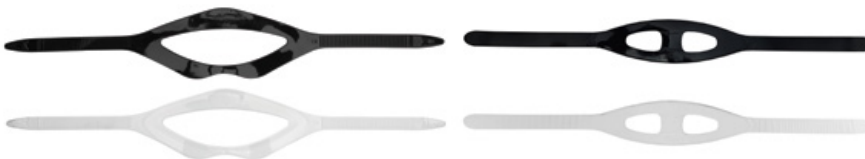

Part #	Description	Material	Retail
AC120BS	Silicone Mask Strap Standard 22 mm Width	Black Silicone	8.50
AC120CL		Clear Silicone	
AC125BS	Silicone Mask Strap Narrow 16 mm Width	Black Silicone	
AC125CL		Clear Silicone	

Replacement Mask Buckle Kits (Pair)



Part #	Description	Retail
AC161	MA100, MA150, MA200 and MA250	8.00
AC162	MA605, MA400 and old styles of MA220 and MA225	
AC163	MA270 and MA280	
AC164	MA210, MA215, MA220, MA225, MA300, MA410, MA415, MA550, MA560, MA600, MA700 (for 22 mm wide strap)	
AC165	Old styles of MA600 and MA700	
AC166	HL702 (Highland Brute Mask)	
AC168	MA420 and MA620 and MRX	
AC169BK	Female receptacle for AC164 / With integrated hinge for MA120 and MA290	
AC169CL		
AC170BK	Alternate female receptacle for AC164 / without integrated hinge	
AC170CL		
AC171	MA500 (Stalker Masks), MA510 (Agnos Masks)	
AC174	MA330 (Diamond Mask), SP200, SP220 (for 16 mm wide strap)	
AC172	MA405BS (Crew Mask), MAH400BS (Dark Water), MAH405BS (Outer Limits)	8.00

Mask Storage Box

- Included with all XS Scuba masks
- Durable, resealable plastic container with blue lid
- Fits most masks



Dimensions
8.5 x 4 x 3.75 in
22 x 10 x 9.5 cm

Part #	Description	Retail
AC110	Mask Box	6.50

Mask Strap Retainers (10 Pack)



Part #	Description	Color	Retail
AC186	Retainers for 16 mm - 10 Pack	Black	10.00
AC187	Retainers for 16 mm - 10 Pack	Clear	
AC188	Retainers for 22 mm - 10 Pack	Black	
AC189	Retainers for 22 mm - 10 Pack	Clear	

Universal X-Strap Mask Strap - Upgrade

- Upgrade for most masks
- Easy to install - no tools needed
- Contoured X-Strap fits comfortably on back of head
- Squeeze top/bottom to release strap

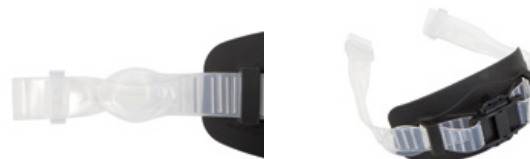

CE

Part #	Description	Retail
AC120UNIV	Universal X-Strap	20.00

X-Strap Mask Strap - Replacement

- Designed for upgrade on XS Scuba masks
- Ultimate in ease for in water adjustment of mask
- Contoured X-Strap fits comfortably on back of head

Fits: Fusion 3, Fusion 2, Gauge Reader, Cortez, M-Line, Merge 3, Goby & Diamond masks.



CE

Part #	Description	Retail
AC120CZ	Replacement X-Strap	20.00

SEADIVE



Acquired by XS Scuba in 2016, the SeaDive brand is best known for its diving masks with proprietary, vision-enhanced lenses. Under the trade names RayBlocker®, TrueColor™, and Hydrophobic™, these masks reduce glare, block harmful UV rays and increase depth perception. Due to their growing popularity, many companies are trying to imitate, but none have been successful in achieving the benefits of these unique and exclusive lens coatings.

SEADIVE RayBlocker®-HD

RayBlocker®-HD coatings perform well in all daytime applications. They are exceptional on sunny days because they are so effective at reducing UV rays and glare.

Light passing through the lens is refined by Sharper Image Technology, which provides enhanced edge definition, making subjects appear as if they are in high-definition.

The inside coating is a blue tint that reduces eye strain and prevents squinting.

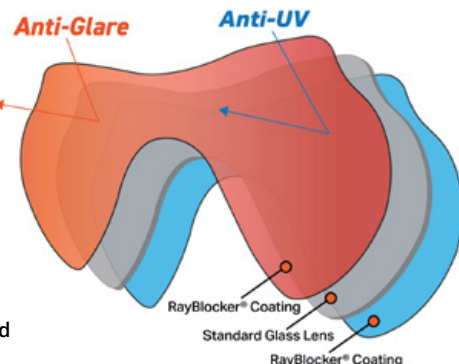

Eagleye - RayBlocker®-HD

- Our most popular RayBlocker® model!
- Easy-adjust buckles are attached directly to the mask skirt for a better, more comfortable seal (non-purge model)
- The single lens provides an unobstructed field of view
- Also available with purge valve
- Fog resistant coating
- Plastic box with lid included



Part #	Color	Description	Retail
SMA975BS	Black	Eagleye Mask	130.00
SMA975WH	White		
SMA953BS	Black	Eagleye Mask with Purge	135.00

SeaScape - RayBlocker®-HD

- The SeaScape 2-window mask is the latest addition to the SeaDive line of RayBlocker®-HD masks
- 2-window frameless means it is lightweight and streamlined
- Molded from soft, hypoallergenic black silicone
- Ratcheting buckle system for easy adjustment
- Wide mask strap stays in position
- Double seal around edge of mask skirt to keep water out



Part #	Description	Retail
SMA960BS	SeaScape Mask	130.00

SeaDiver - RayBlocker®-HD

- Easy-adjust buckles are attached directly to the mask skirt for a better, more comfortable seal
- Easy access nose pocket
- Wide strap keeps mask in the perfect position
- Fog resistant coating
- Plastic box with lid included



Part #	Description	Retail
SMA540BS	SeaDiver Mask	130.00

SeaFire - RayBlocker®-HD *Freediving*

- RayBlocker® lenses, using Sharper Image Technology, provide a brighter, sharper image
- Reduces harmful UV rays and glare
- Rather than use a traditional "snap-together" frame, the SeaFire mask uses an integrated frame to keep the volume low and keep drag to a minimum
- Swivel buckles are integrated into the mask frame
- Plastic box with lid included



Part #	Description	Retail
SMA930BS	SeaFire Mask	148.00

EyeMax - RayBlocker®-HD

- Our most popular 2-window mask!
- Drop-point style lenses provide excellent downward viewing so that you can better see your dive equipment and attachment points
- Easy-adjust buckles are attached directly to the mask skirt for a better, more comfortable seal
- Fog resistant coating
- Plastic box with lid included



Part #	Description	Retail
SMA977BS	EyeMax Mask	130.00

SeaRover - RayBlocker®-HD

- The single lens mask provides an unobstructed view
- Drop point lens design offers excellent downward field of view
- Easy-adjust buckles are attached directly to the mask skirt for a better, more comfortable seal
- Fog resistant coating
- Plastic box with lid included



Part #	Description	Retail
SMA950BS	SeaRover Mask	130.00



Monarch - RayBlocker®-HD Frameless

- The Monarch frameless mask fits most faces
- Single-piece construction so it is very lightweight
- The single lens provides an unobstructed field of view
- Easy-adjust buckles are attached directly to the mask skirt for a better, more comfortable seal
- Plastic box with lid included



Part #	Description	Retail
SMA980BS	Monarch Frameless Mask	130.00

SeaLite - RayBlocker®-HD Frameless

- The SeaLite frameless mask features single-piece construction so it is very lightweight
- The single lens provides an unobstructed field of view
- Drop-point style lenses provide excellent downward viewing so that you can better see your dive equipment and attachment points
- Easy-adjust buckles are attached directly to the mask skirt for a better, more comfortable seal
- Plastic box with lid included



Part #	Description	Retail
SMA963BS	SeaLite Frameless Mask	130.00

SeaClear RayBlocker®-HD Mask

The SeaClear 2-window mask is the latest addition to the SeaDive line of RayBlocker®-HD masks.

- RayBlocker®-HD lens coatings use Sharper Image Technology, which provides enhanced edge definition, making subjects appear as if they are in high-definition
- Effectively reduces glare and UV
- The SeaClear Mask is available in black, hypoallergenic silicone and is sure to fit most faces
- The ratcheting buckle system is easy to adjust with gloves on



Part #	Description	Retail
SMA940BS	SeaClear Mask	130.00

SeaClear RayBlocker®-HD Mask with Corrective Lens Option

If you prefer to purchase the SeaClear RayBlocker®-HD Mask with corrective lenses, you can purchase the mask with no lenses and 2 corrective lenses and snap it together yourself. It's quick and easy.



Part #	Description	Retail
SMA945Rx	SeaClear Corrective Lens Mask (lenses sold separately)	210.00 <i>Retail price for mask with 2 lenses</i>

Part #	Diopter	Retail	Part #	Diopter	Retail
LSR15	-1.5	52.00	LSR45	-4.5	52.00
LSR20	-2.0		LSR50	-5.0	
LSR25	-2.5		LSR55	-5.5	
LSR30	-3.0		LSR60	-6.0	
LSR35	-3.5		LSR65	-6.5	
LSR40	-4.0				

TrueColor™-HD

The TrueColor™ coatings are effective in compensating for reduced light and reduced colors as found underwater.

The TrueColor™ with yellow tint on the inside, provides the best performance in lower light conditions such as early mornings, late afternoons or deeper depths. It makes everything seem brighter underwater and provides increased contrast.

The TrueColor™ with rose tint on the inside, filters out unwanted blue light, thereby making the warm colors of the reef (reds, oranges & yellows) more pronounced and vibrant.

Both models have a blue mirror coating on the outside, which reduces harmful UV rays and glare.

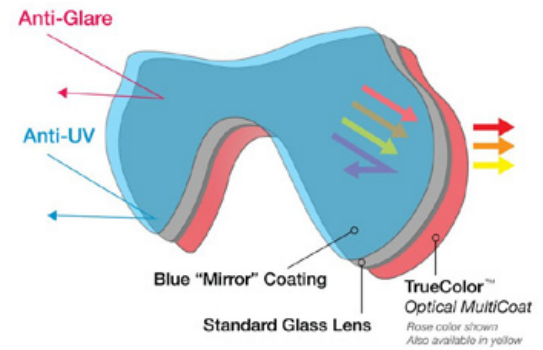

Eagleye - TrueColor™-HD

- The single lens provides an unobstructed field of view
- Easy-adjust buckles are attached directly to the mask skirt for a better, more comfortable seal (non-purge model)
- Fog resistant coating
- Plastic box with lid included



Before & after with rose tint



Available With Purge

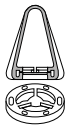

Part #	Inside Coating	Description	Retail
SMA638BS	Yellow	Eagleye - TrueColor™ HD Mask	130.00
SMA639BS	Rose		
SMA646BS	Yellow	Eagleye - TrueColor™ HD Mask with Purge	135.00
SMA647BS	Rose		

Hydrophobic™

Hydrophobic™ coatings use nano-technology to fill in the tiniest surface imperfections in the glass. This process leaves the glass surface so slick, even the smallest water vapor droplets are unable to attach. This provides two benefits:

Upon surfacing, droplets don't form on the glass, allowing unobstructed vision. The inside is resistant to fog.

The Hydrophobic™ coating provides the best fog resistant performance of all Seadive masks.

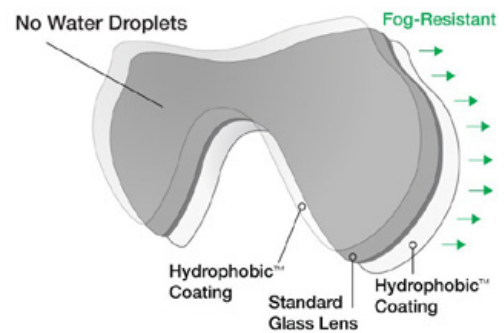

Eagleye - Hydrophobic™

- The Eagleye is the most popular frame in the Seadive line. It provides excellent peripheral and downward vision
- Easy-adjust buckles are attached directly to the mask skirt for a better, more comfortable seal
- Fog resistant coating
- Plastic box with lid included



Part #	Color	Description	Retail
SMA801BK	Black	Eagleye Hydrophobic™ Mask	95.00
SMA801BS	Black Silicone		
SMA801BU	Blue		
SMA801CL	Clear		



OCEANways

Oceanways® is a brand targeting the snorkeling enthusiast. The masks, snorkels, fins and especially the mask / snorkel combination sets are geared for the price-conscious.

The Oceanways® products use some of the technologies found in the SeaDive professional masks, such as high definition lens coatings. Since the products are robust and economically priced, they are often found in high-use situations such as rental departments, training programs and resorts.

If the price of professional scuba equipment is creating a barrier to entry for your casual snorkelers, consider the Oceanways® brand and keep them snorkeling.

OCEANways® SuperView-HD

- SeeSharp High Definition Lens
 - Sharpens underwater viewing
 - Reduces distortion by defining faint edges
 - Filters out UV and glare
- Changes white light harshness to a calming blue light for less eye strain
- SeeSharp HD Lenses, which appear orange on black silicone masks, appear blue on white silicone masks. The benefits remain the same
- Plastic box with lid included

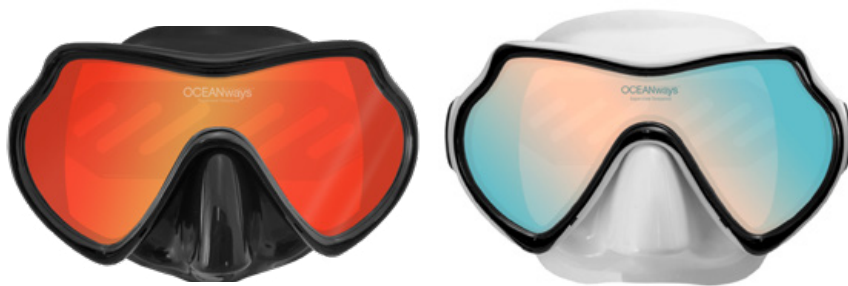

Part #	Color	Description	Retail
OMA940BS	Black Silicone	Oceanways SuperView-HD Mask	94.00
OMA940WH	White Silicone		

OCEANways® OceanCat-HD

- SeeSharp High Definition Lenses
 - Sharpens underwater viewing
 - Reduces distortion by defining faint edges
 - Filters out UV and glare
 - Refines what you see for better definition
- Changes white light harshness to a calming blue light for less eye strain
- Plastic box with lid included



Part #	Description	Retail
OMA964BS	Oceanways OceanCat-HD Mask	94.00

OCEANways® SuperView - AccuColor

- The blue mirror exterior removes glare
- **Yellow Tint** – makes everything seem brighter and increases contrast
- **Rose Tint** – filters out blue light making warm colors more vibrant
- Fog-resistant coating
- Plastic box with lid included



Part #	Tint Color	Description	Retail
OMA836BS	Yellow	SuperView - AccuColor Mask	94.00
OMA837BS	Rose		

OCEANways® SuperView SLX

- Molded from soft, hypoallergenic silicone
- Double seal around edge of mask skirt keeps water out
- Ratcheting buckle system is easy to adjust
- Wide mask strap stays in position
- Comes in polybag or mask box



Part #	Color	Description	Retail
OMA675BK	Black	SuperView SLX Mask	72.00
OMA675BS	Black Silicone		
OMA675BU	Blue		
OMA675CL	Clear		
OMA675YL	Yellow		
OMA675BK-BOX	Black	Oceanways SuperView SLX Mask - Boxed	77.00
OMA675BS-BOX	Black Silicone		
OMA675BU-BOX	Blue		
OMA675CL-BOX	Clear		
OMA675YL-BOX	Yellow		

OCEANways® Spectre Frameless

- The Spectre is frameless, so it is lightweight
- Molded from soft, hypoallergenic silicone
- Ratcheting buckle system allows for easy strap adjustment
- Wide mask strap stays in position
- Double seal around the edge of the mask skirt keeps water out
- Comes in polybag or mask box



Part #	Description	Retail
OMA780BS	Oceanways Spectre Mask	61.00
OMA780BS-BOX	Oceanways Spectre Mask - Boxed	66.00

OCEANways® Caribbean

- Molded from soft, hypoallergenic silicone
- Fits most faces
- Double seal around edge of mask skirt keeps water out
- Ratcheting buckle system is easy to adjust
- Wide mask strap stays in position
- Comes in polybag or mask box



Part #	Color	Description	Retail
OMA485BS	Black Silicone	Oceanways Caribbean Mask	36.00
OMA485BU	Blue		
OMA485YL	Yellow		
OMA485BS-BOX	Black Silicone	Oceanways Caribbean Mask - Boxed	41.00
OMA485BU-BOX	Blue		
OMA485YL-BOX	Yellow		

OCEANways® Pacific Mask

- Traditional oval, one-window design
- The band on the mask frame is 304 stainless steel
- Available with black, liquid-injection molded silicone skirt
- Uses secure, stainless steel wire buckles
- Strap width is 0.87 in (22 mm)
- Tempered glass meets ANSI Standards for impact resistance
- Comes in polybag. Does not fit in traditional mask box



Part #	Color	Description	Retail
OMA843BS	Black Silicone	Oceanways Pacific Mask	62.00

OCEANways® Dry Snorkel

- Auto-closure device on top keeps water out
- Silicone mouthpiece and flex connector
- Self-draining valve under mouthpiece expels residual water



Part #	Color	Description	Retail
OSN305BS	Black Silicone	Oceanways Dry Snorkel	32.00
OSN305BU	Blue		
OSN305YL	Yellow		

OCEANways® Caribbean

- Wave Guard deflector keeps out splash water
- "V" bite silicone mouthpiece
- Partial drop-away silicone flex connector
- Large drain valve below mouthpiece



Part #	Color	Description	Retail
OSN207BS	Black Silicone	Oceanways Caribbean Snorkel	40.00
OSN207BU	Blue		
OSN207YL	Yellow		
OSN207WH	White		

OCEANways® AquaPro Fins

- Full-foot rubber fins provide unsurpassed comfort and efficiency
 - Less ankle fatigue
 - Greater propulsion
- These are the most popular type of fins for snorkeling, swim training and rental departments
- Ideal-fitting foot pocket
- Made in the USA



Part #	Size	Description	Retail
OFN1146	2-3	Oceanways AquaPro Jr. Fins	38.00
OFN1147	3-4		
OFN1140	5-7		
OFN1141	7-8.5	Oceanways AquaPro Fins	42.00
OFN1142	8.5-10		
OFN1143	10-12		
OFN1144	12-14		

OCEANways® Propel Fins

- Use with bare feet or lightweight booties
- Quick and easy adjustable heel straps
- Much more range of fit than shoe fins
- Soft thermoplastic rubber heel strap & foot pocket
- Lightweight and easy for travel
- Perfect for snorkeling
- Colors: blue with black accents or yellow with black accents

Mesh Bag Included



Bare Feet

Part #	Size	Fits	Color	Overall Length	Retail
OFN201BU	Junior	9 to 13	Blue	18.75 in (47.5 cm)	49.00
OFN201YL	Junior	9 to 13	Yellow		
OFN202BU	Junior	1 to 4	Blue	21.5 in (54.5 cm)	
OFN202YL	Junior	1 to 4	Yellow		
OFN203BU	Adult	4.5 to 8.5	Blue	22 in (56 cm)	55.00
OFN203YL	Adult	4.5 to 8.5	Yellow		
OFN204BU	Adult	9 to 13	Blue	23.5 in (60 cm)	
OFN204YL	Adult	9 to 13	Yellow		

SEADIVE | OCEANways® Replacement Mask Buckle Kits (Pair)

SMP120
Used on masks where the buckles attach to the frame.



SMP122
Used on masks where the buckles attach to the mask skirt.



SMP125
Used on SeaScape and UltraVision Masks.



Part #	Description	Retail
SMP120	Replacement Mask Buckles (Pair)	6.00
SMP122		
SMP125		

OCEANways® SeeSharp Dry Combo

- SeeSharp High Definition Mask
 - Sharpens underwater viewing
 - Reduces distortion by defining faint edges
 - Filters out UV and glare
- Dry Snorkel has auto-closure device on top to keep water out
- Silicone mouthpiece, connector tube and purge valve



Part #	Description	Retail
SP845BS	Oceanways SeeSharp Dry Combo	95.00

OCEANways® SeeSharp Combo

- SeeSharp High Definition Mask
 - Sharpens underwater viewing
 - Reduces distortion by defining faint edges
 - Filters out UV and glare
- Caribbean Snorkel with Wave Guard deflector top
- "V" bite silicone mouthpiece and flex tube



Part #	Color	Description	Retail
SP844BS	Black Silicone	Oceanways SeeSharp Combo	84.00
SP844WH	White Silicone		

OCEANways® SeeSharp SL Combo

- All the same great features as the SeeSharp Combo but in a single lens configuration



Part #	Description	Retail
SP843BS	Oceanways SeeSharp SL Combo	85.00

OCEANways® Caribbean Combo

- Caribbean Mask with tempered glass
- Mask skirt molded from hypoallergenic silicone
- Ratcheting buckle system is easy to adjust
- Dry Snorkel has auto-closure device on top to keep water out
- Silicone mouthpiece, connector tube and purge valve



Part #	Color	Description	Retail
SP309BS	Black Silicone	Oceanways Caribbean Combo	57.00
SP311YL	Yellow		
SP312BU	Blue		

OCEANways® Youth SeaLife Combos

Ratchet up the fun with these youth mask/snorkel combos that mimic interesting marine life. The orange combo captures the wild colors of the mandarin fish while the yellow combo portrays the elegance of the purple and yellow nudibranch. New for 2024, the pink and blue batwing slug edition adds a splash of psychedelic color to your snorkeling adventures.

- Hypoallergenic mask for quality fit with comfort
- Elastic strap with built-in snorkel retainer
- Silicone snorkel mouthpiece
- Automatic dry top closure device
- Water transfer coating has a protective layer which gives it a silky feel. It will not chip, flake or fall off



CE

Part #	Style	Description	Retail
SP240 	Bat Wing Slug	Youth SeaLife Combos	61.50
SP200	Mandarin Fish		
SP220	Purple/Yellow Nudibranch		
AC115	Replacement Strap	Complete Junior Assembly	13.50



Photo by Jake Lords @bigjakelords

Passage Dry Snorkel

The Passage snorkel represents the latest in snorkel dry top technology. This highly efficient dry top, coupled with a self-draining lower end, results in an easy and comfortable snorkeling experience. The quick release snorkel keeper and removable silicone mouthpiece just add whip cream to your snorkeling adventure!

- Patented dry top prevents water from entering at the surface or underwater
- Self-draining purge valve at the bottom allows any water to exit
- Reservoir at the lower end allows you to breathe past small amounts of residual water
- Comfy-bite mouthpiece uses a unique bridge that runs behind your front teeth to hold it firmly in place. This avoids clenching and allows you to relax your jaw
- Mouthpiece is replaceable and can be changed out for a smaller or standard model
- Flex tube allows the mouthpiece to drop out of the way when not being used
- Quick-release snorkel keeper allows for easy removal from the mask



CE

Part #	Color	Description	Retail
SN120BI	Blk Sil / Blue Ice*	Passage Dry Snorkel	55.00
SN120BS	Blk Sil / Black		
SN120BU	Blue		
SN120CL	Clear		
SN120PK	Pink		
SN120RD	Blk Sil / Fire Red*		
SN120TA	Transparent Aqua		
SN120TB	Transparent Blue		
SN120TP	Transparent Purple		
SN120TY	Transparent Yellow		
SN120WH	Blk Sil / White		
SN120YL	Blk Sil / Yellow		

*Premium air-brushed color

Sedona Elite Dry

- Sleek design dry top
- Patented top prevents water entering while underwater
- Guards against water entering at surface
- Smooth bore silicone flex tube
- Replaceable curved mouthpiece
- Self-draining purge valve
- Quick-release snorkel keeper for easy removal from mask



CE

Part #	Color	Description	Retail
SN050BK	Black	Sedona Elite Dry Snorkel	50.00
SN050BI	Blue Ice*		
SN050BU	Blue		
SN050CL	Clear		
SN050RD	Fire Red*		
SN050YL	Yellow		

**Premium air-brushed color*

3D Flex Dry

- The original dry snorkel! Nothing else compares!
- Unique floating valve system closes on contact with water
- Dry top opens automatically upon surfacing to eliminate vacuum effect
- Adjustable mouthpiece with swivel ball joint
- Smooth bore corrugated silicone tube allows mouthpiece to drop out of the way when scuba diving
- Quick-release snorkel keeper for easy removal from masks



CE

Part #	Color	Description	Retail
3DF-BS	Black Silicone	3D Flex Dry Snorkel	61.00
3DF-BU	Crystal Blue		
3DF-CL	Crystal Clear		
3DF-YL	Crystal Yellow		

Cargo

For those that don't like to wear a snorkel but think it may be a good idea to have one "just in case", we offer the Cargo Snorkel. Just roll it up, secure the tip to the customized snorkel keeper, and stow it in your pocket. When it's time to use it, simply unclip it, because it is 100% silicone, it pops back into its original shape. It's clever! It's compact! It's Cargo!

- Roll up and stow in your BC pocket
- Carry this snorkel out of your way
- 100% silicone construction
- Self-draining purge valve
- Special snorkel keeper to keep it rolled up
- Compact design



Packaging shown above



Roll up and stow in your BC pocket



CE

Part #	Color	Description	Retail
SN650BS	Black Silicone	Cargo Snorkel	38.00
SN650CL	Clear Silicone		

FLO

The FLO snorkel is a quality, contoured, open top snorkel. Since the lower end is a traditional, non-purge type, it allows for the displacement clearing technique. This makes FLO a favorite among freedivers, spearos and veteran scuba divers. Go with the tried and true design.

- Contoured shape minimizes drag
- Open top design maximizes gas exchange
- Non-purge mouthpiece allows for the displacement clearing method
- The internal bore is smooth to prevent residual water
- Easy-to-use adjustable snorkel keeper
- Uses a silicone mouthpiece



CE

Part #	Color	Description	Retail
SN500BS	Black	FLO Snorkel	33.00
SN500GN	Green		
SN500BU	Blue		

Ambush

The Ambush snorkel is the obvious choice to complete the Stalker Camo masks. Using the same water transfer technology as the masks, they blend beautifully with the Stalker mask and the environment. The Ambush is comfortable in the mouth and contoured perfectly to your head.

- For the purists, the Ambush is a traditional open-top design
- The non-purge mouthpiece allows for the displacement clearing method
- Uses a traditional "figure 8" snorkel keeper
- Contours to the head to minimize drag
- Comfortable silicone mouthpiece can be rotated into the perfect position



CE

Part #	Color	Description	Retail
SN510BS-CAMO	Black Camo	Ambush Snorkel	38.00
SN510BU-CAMO	Blue Camo		
SN510GN-CAMO	Green Camo		

Bypass Elite

- Streamlined semi-dry top
- Guards against water entering at surface
- Smooth bore silicone flex tube
- Replaceable curved mouthpiece
- Self-draining purge valve
- Quick-release snorkel keeper for easy removal from mask



CE

Part #	Color	Description	Retail
SN400BK	Black	Bypass Elite Snorkel	33.00
SN400BU	Blue		
SN400CL	Clear		
SN400YL	Yellow		

Metro

- Value priced and built tough
- Traditional open top
- Self-draining purge valve
- Comfortable curved mouthpiece design
- Flex section for comfortable positioning
- Quick-release snorkel keeper for easy removal from mask



CE

Part #	Color	Description	Retail
SN600BK	Black Silicone	Metro Snorkel	30.00
SN600BU	Blue		
SN600CL	Clear		
SN600YL	Yellow		

Porto

The brightly colored Porto Snorkels match up well with the black silicone models in the Metro Mask Series.

- Porto Snorkels are pliable and can be folded
- Includes figure 8 standard snorkel retainer
- Comfortable silicone mouthpiece
- Contoured shape stays close to the head to reduce drag
- Open top



CE

Part #	Color	Description	Retail
SN520BS/BK	Black	Porto Snorkel	33.00
SN520BS/BU	Blue		
SN520BS/GN	Green		
SN520BS/OR	Orange		
SN520BS/RD	Red		
SN520BS/YL	Yellow		

Goby Dry

- Totally dry snorkel top
- Patented top prevents water from entering
- Easy to clear with self-draining purge valve
- Silicone mouthpiece designed for youths
- Adjustable snorkel keeper



CE

Part #	Description	Color	Retail
SN700BU	Blue	Goby Dry Snorkel	30.00
SN700YL	Yellow		

Figure 8 Snorkel Keepers - 10 Pack

- Keep it simple and go with the tried-and-true
- All silicone construction



Part #	Description	Retail
AC153	Black Silicone Snorkel Keeper - 10 Pack	3.00 ea.
AC154	Clear Silicone Snorkel Keeper - 10 Pack	

Snorkel Keepers

AC146



Push Button Release

AC147



AC148



AC149

Universal Style Fits
Most Snorkels

Push Button Release

AC150 (round) - AC151 (oval)

Part #	Description	Retail
AC146	Cargo Snorkel Keeper	6.00
AC147	Viper Snorkel Keeper	
AC148	FLO Snorkel Keeper	
AC149	Goby Snorkel Keeper	
AC150	Quick-Release Snorkel Retainer - Round	
AC151	Quick-Release Snorkel Retainer - Oval	

Snorkel Mouthpiece

XS Scuba offers a wide selection of high-quality silicone mouthpieces that fit most of today's popular models.

3 styles available

Standard - uses traditional bite tabs

Slim - popular with women and younger snorkelers

Comfy - has a unique bridge that fits across the upper palate that holds the mouthpiece in place. This prevents clenching and reduces jaw fatigue

- Injection molded from liquid silicone
- No tie wrap necessary



Standard



Slim



Comfy

Part #	Material	Description	Retail
AC130BS	Black Silicone	Snorkel Mouthpiece - Standard	8.50
AC130CL	Clear Silicone		
AC137BS	Black Silicone	Snorkel Mouthpiece - Slim	
AC137CL	Clear Silicone		
AC138BS	Black Silicone	Snorkel Mouthpiece - Comfy	9.50
AC138CL	Clear Silicone		
AC139CL	Clear Silicone	Goby Replacement Mouthpiece <i>(does not include purge assy.)</i>	9.50
AC141	Black Silicone	Porto Snorkel Mouthpiece	5.50

Snorkel Purge Valves

- Replacement parts
- Injection-molded from liquid silicone



AC131

AC132

AC134

AC136

OSP130

Part #	Diameter	Fits	Retail
AC131	19 mm	Fits Goby, Sedona, Sedona Elite, Bypass Elite, Viper, Metro & Oceanways 305 Dry Snorkel	4.00
AC132	17 mm	Fits Cargo Snorkel	
AC134	22 mm	Fits Alert Snorkel	
AC136	24 mm	Fits 3DF Snorkel	
OSP130	18 mm	Fits Oceanways Caribbean Snorkel	

APTOS Freediving Fins



The Aptos Fins are the ideal choice for freediving students, novices and enthusiasts. The attractive price point lessens the barrier to getting started. The foot pockets are extremely comfortable and will accept more advanced blades as the novice moves on in their skills and experience. Foot pockets are also sold separately.

- Universal rubber foot pockets accept a wide variety of blades
- Comes with a polypropylene blade
- Six sizes are available
- *Foot pockets and blades ship separately. **Assembly required***



Part #	Description	Men's Shoe Size	Length	Retail
FN120	Aptos Fins, Complete PAIR	5 - 6	826 mm	110.00
FN121		7 - 8	841 mm	
FN122		8.5 - 9.5	855 mm	
FN123		10 - 11	871 mm	
FN124		12 - 13	884 mm	
FN125		13 - 14	900 mm	
FN130	Foot Pockets Only	5 - 6	-	60.00
FN131		7 - 8		
FN132		8.5 - 9.5		
FN133		10 - 11		
FN134		12 - 13		
FN135		13 - 14		
Part #	Description			Retail
FN140	Fin Blade, Aptos, PAIR - Black			50.00



Phenom Fins

What do you get when you blend the best design features of the industry's leading fins? Phenomenal performance! Introducing Phenom, XS Scuba's high-performance fin for scuba diving.

- Phenom fins start with an iconic blade design that creates super channels on both the upstroke and downstroke. The channels direct the water longitudinally down the length of the blade, preventing spill over the side ribs
- The blade is attached to a soft, comfortable foot pocket at the mid-foot position, as opposed to the front. This prevents hyper-extension of the toes and ankle and allows the entire foot to be used while diving the fin
- "Stretch Straps", with large finger loops and quick-release buckles, are comfortable, secure and convenient
- Raised ribs on the foot plate alleviate the suction effect when taking off the fins
- Molded from a proprietary composite material coupled with thermoplastic rubber, the Phenom Fins take comfort and efficiency to a whole new level



Part #	Color	Size	Men's Shoe Size	Description	Retail
FN610BK	Black	Small	4-7.5	Phenom Fins	132.00
FN611BK		Regular	8-10.5		
FN612BK		Large	11-15		
FN610BU	Blue	Small	4-7.5		
FN611BU		Regular	8-10.5		
FN612BU		Large	11-15		
FN610YL	Yellow	Small	4-7.5		
FN611YL		Regular	8-10.5		
FN612YL		Large	11-15		

Cortez II

The Cortez II is for the budget-minded individual that wants a well-constructed, comfortable fin without breaking the bank. The comfort and ease-of-donning is due to the unique silicone compound found in the "Stretch Straps". The performance is delivered by the flexible center channel and the blade materials selected.

- Flexible center channel improves power and efficiency
- Co-molded thermoplastic material
- Includes silicone "Stretch Straps" with quick-release buckles
- Colors: all black or blue with black accents
- Includes mesh tote bag

Mesh Bag Included

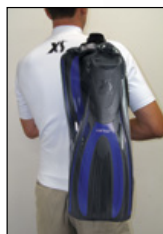

Part #	Size	Color	Men's Shoe Size	Overall Length	Retail
FN702BK	Medium	Black	9-10	25.5 in (65 cm)	110.00
FN702BU		Blue			
FN703BK	Large	Black	11-12	27.5 in (70 cm)	
FN703BU		Blue			
FN704BK	X-Large	Black	13-14	27.5 in (70 cm)	
FN704BU		Blue			



Turtle Fins

- A classic favorite
- 3XL size popular among drysuit divers because of the very large foot pocket
- Compression molded, rubber construction
- Provides exceptional speed with minimal effort
- Available with Highland Spring Straps pre-installed



Size 3XL Only



Available with Spring Straps installed

Part #	Size	Overall Length	Overall Width	Weight	Retail
FN303	XL	19.25 in (49 cm)	9.75 in (24.8 cm)	5.5 lbs (2.5 kg)	165.00
FN304	2XL	20.25 in (51.5 cm)	10.0 in (25.4 cm)	5.8 lbs (2.6 kg)	
FN305	3XL	20.50 in (52 cm)	10.0 in (25.4 cm)	7.0 lbs (3.2 kg)	
Part #	Size	Description			Retail
FN303-SS10	XL	Turtle Fin w/ 10" (25.4 cm) SS Spring Strap			240.00
FN304-SS10	2XL	Turtle Fin w/ 10" (25.4 cm) SS Spring Strap			
FN305-SS12	3XL	Turtle Fin w/ 12" (30.5 cm) SS Spring Strap			

Power Fins

- Classic "Old School" fins and a favorite of experienced divers
- Excellent propulsion and comfort in a vented fin
- Compression molded, rubber construction
- Provides exceptional speed with minimal effort



Part #	Size	Overall Length	Retail
FN202	Medium	18.5 in (47 cm)	121.00
FN203	Large	18.5 in (47 cm)	
FN204	X-Large	20.75 in (52.7 cm)	

Propel

- Use with bare feet or lightweight booties
- Quick and easy adjustable heel straps
- Much more range of fit than shoe fins
- Soft thermoplastic rubber heel strap & foot pocket
- Lightweight and easy for travel
- Perfect for snorkeling
- Colors: blue with black accents or yellow with black accents

Mesh Bag Included



Bare Feet

Part #	Size	Fits	Color	Overall Length	Retail
FN801BU	Junior	9 - 13	Blue	18.75 in (47.5 cm)	49.00
FN801YL	Junior	9 - 13	Yellow		
FN802BU	Junior	1 - 4	Blue	21.5 in (54.5 cm)	
FN802YL	Junior	1 - 4	Yellow		
FN803BU	Adult	4.5 - 8.5	Blue	22 in (56 cm)	55.00
FN803YL	Adult	4.5 - 8.5	Yellow		
FN804BU	Adult	9 - 13	Blue	23.5 in (60 cm)	
FN804YL	Adult	9 - 13	Yellow		

HIGHLAND ENGINEERED QUALITY Technical Spring Straps

Spring heel fin straps are popular because they are comfortable, easy to use and practically indestructible. Highland premium spring fin straps are made from stainless steel springs and covered with nylon tube webbing to protect the spring and keep out grass and other plant matter. The thumb puller is streamlined and designed not to snag on objects like traditional finger loop designs can do. The springs have machined Delrin ends that attach to one of two types of stainless steel adapter fittings with a stainless screw and nylon lock nut. Nylon line on the inside of the spring prevents over-extension of the strap.

- One kit attaches to most brands of scuba fins
- High quality stainless spring & buckles will not rust
- Streamlined thumb pull will not snag
- Internal cave line to prevent overstretching of springs
- Includes "old school" buckles for rubber fins & post buckles for most modern fins

How to Select the Proper Size

- Insert your foot into the fin pocket while wearing a boot
- Measure from the attachment point on one side of the fin, around your heel, to the other side
- Choose the spring straps with an overall length that is approximately 1 inch shorter than this measured distance

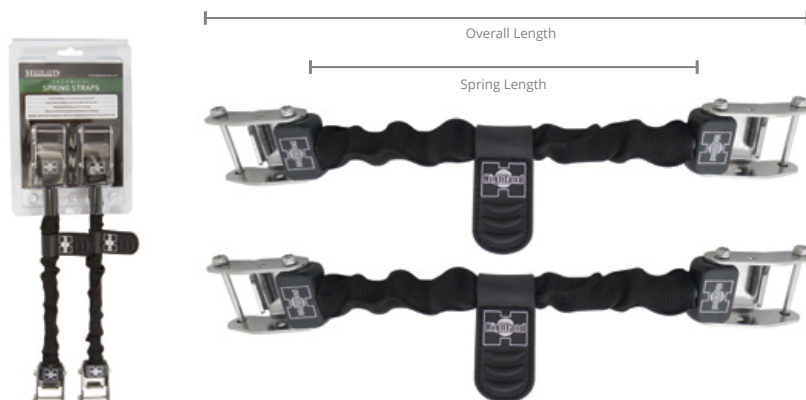

Extra Holes For 1/2 Step Size Adjustments



"Old School" Buckles Included

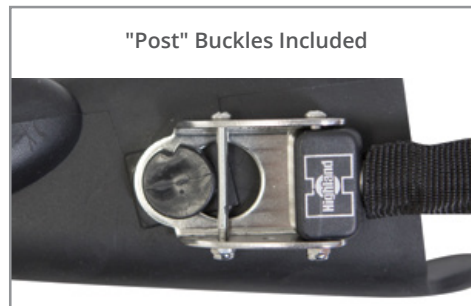

"Post" Buckles Included

Part #	Spring Length	Overall Length	Description	Retail
HL708	8 in (203 mm)	10 in (254 mm)	Technical Spring Straps	88.00
HL710	10 in (254 mm)	12.5 in (318 mm)		
HL712	12 in (305 mm)	14.5 in (368 mm)		
FP04	Nuts & Bolts for Highland Spring Straps (incl. 4 nuts / 4 bolts)			7.00

Standard Spring Straps

- Attaches to most brands of "large post" fins
- Comfort heel pad has a large finger loop, which allows easy on/off, even with thick gloves
- Stronger than traditional rubber straps
- No tightening or adjustments needed
- Passivated 304 stainless spring will not rust
- Internal safety line prevents over-stretching



Part #	Size	Description	Retail
FP30	Small	Standard Spring Straps	45.00
FP33	Medium		
FP36	Large		

Full Foot Fin Retainers

Full Foot Fin Retainers are the simple, effective solution for keeping your full foot fins on your feet. They are an inexpensive way to prevent losing expensive freediving / spearfishing fins. Use them if your fins are a little too big or you kick hard.



Part #	Size	Description	Retail
FP90	Small	Full Foot Fin Retainers (Pair)	9.00
FP91	Medium		
FP92	Large		

Phenom and Cortez II Stretch Straps

- Manufactured by liquid silicone injection
- Extremely stretchy and strong
- Better ozone and UV light resistance than traditional rubber straps
- Built-in pull loop for easier on and off
- One single strap, not a pair
- Does not include female buckles



Part #	Size	Description	Silicone Length	Overall Length	Retail
FP14	XS/S	Stretch Strap Single	7.9 in / 201 mm	9.7 in / 246 mm	15.00
FP15	M/L		8.9 in / 226 mm	10.6 in / 270 mm	
FP16	L/XL		9.8 in / 249 mm	11.6 in / 295 mm	

Universal Fin Strap Assembly

- Fits most modern fins
- Finger tab on strap for easier grip
- Complete assembly with male/female buckles
- Easy adjustable quick-release buckles
- One complete assembly for one fin, not a pair
- Black rubber material - 1 in (25 mm) width



Part #	Description	Retail
FP02	Replacement Universal Fin Strap Assembly - Single	11.00

Propel Fin Strap Assembly

- Fits XS Scuba Propel Fin
- Finger tab on strap for easier grip
- Complete assembly with male buckles & strap
- Easy adjustable quick-release buckles
- One complete strap assembly, not a pair
- Black TPR material - 1 in (25 mm) width



Part #	Description	Retail
FP05	Replacement Propel Fin Strap & Buckle Assembly - Single	11.00

“Old School” Rubber Fin Strap

- Fits “Old School” fins - Turtle, Power, Frog, Rocket, Jet, etc.
- Finger tab on strap for easier grip
- One single strap, not a pair
- Black rubber material - 1 in (25 mm) width



Part #	Description	Retail
FP03	Replacement “Old School” Rubber Fin Strap - Single	6.50
FP01	Replacement Buckles & Pins Kit (4 sets for two fins)	15.00

Deluxe Zipper Boots

- A neoprene panel behind the zipper acts as a coldwater dam
- Large size number printed on the coldwater dam
- The "SureGrip" sole prevents slipping
- Protective heel cap prevents fin strap abrasion
- Extended toe cap runs up the top of the boot to prevent wear from fin
- Glued and blind stitched
- #10 YKK Delrin Zipper
- Nylon zipper stop



*Our Most Popular
Best Selling Boot Ever!*

Available in 3 Thicknesses
3 mm - 5 mm - 6.5 mm

Part #	Size	Description	Retail
BT300-05	05	3 mm Deluxe Zipper Boots	66.00
BT300-06	06		
BT300-07	07		
BT300-08	08		
BT300-09	09		
BT300-10	10		
BT300-11	11		
BT300-12	12		
BT300-13	13		
BT300-14	14		
BT300-15	15		
Part #	Size		
BT500-03	03	5 mm Deluxe Zipper Boots	66.00
BT500-04	04		
BT500-05	05		
BT500-06	06		
BT500-07	07		
BT500-08	08		
BT500-09	09		
BT500-10	10		
BT500-11	11		
BT500-12	12		
BT500-13	13		
BT500-14	14		
BT500-15	15		
Part #	Size	Description	Retail
BT650-05	05	6.5 mm Deluxe Zipper Boots	70.00
BT650-06	06		
BT650-07	07		
BT650-08	08		
BT650-09	09		
BT650-10	10		
BT650-11	11		
BT650-12	12		
BT650-13	13		
BT650-14	14		
BT650-15	15		

8 mm Thug Zipper Boots

Tough and Warm

- 8 mm neoprene in all panels including sole
- High abrasion resistant RynoHyde exterior lamination
- Heavy-duty molded rubber sole
- Protective heel and toecap
- YKK's best marine bronze #10 zipper slider
- Hook-and-loop tab zipper retainer
- Glued and double blind stitched exterior and interior





Part #	Size	Description	Retail
BT800-04	04	8 mm Thug Zipper Boots	94.00
BT800-05	05		
BT800-06	06		
BT800-07	07		
BT800-08	08		
BT800-09	09		
BT800-10	10		
BT800-11	11		
BT800-12	12		
BT800-13	13		
BT800-14	14		

3 mm Tropic Boots

- Lightweight and rugged
- Extended heel for fin strap protection
- Aggressive "SureGrip" vulcanized rubber sole
- Soft nylon lining
- Glued and double blind stitched



Part #	Size	Description	Retail
 BT350-03	03	3 mm Tropic Boots	44.00
 BT350-04	04		
BT350-05	05		
BT350-06	06		
BT350-07	07		
BT350-08	08		
BT350-09	09		
BT350-10	10		
BT350-11	11		
BT350-12	12		
BT350-13	13		
BT350-14	14		
BT350-15	15		

2 mm Neoprene Socks

- Foot protection from fin wear
- Extended heel for fin strap protection
- Rubberized textured bottoms
- Soft nylon lining
- Glued and blind stitched



Part #	Size	Description	Retail
BT200-05	05	2 mm Neoprene Socks	28.00
BT200-06	06		
BT200-07	07		
BT200-08	08		
BT200-09	09		
BT200-10	10		
BT200-11	11		
BT200-12	12		

Beefy Socks

- Take the effort out of putting on your wetsuit & boots
- Reduce foot discomfort with full foot fins
- Heavy 280 g/m² four-way stretch Polyolefin fleece material
- One size fits most
- Made with flat-lock stitching



Part #	Description	Retail
BT150	Beefy Socks	21.00

Spandex Socks

- Take the effort out of putting on your wetsuit & boots
- Reduce foot discomfort with full foot fins
- 6 ounce, four-way stretch spandex
- Made with overlock stitching
- One size fits most



Part #	Color	Description	Retail
BT100BK	Black	Spandex Socks	14.00
BT100BU	Blue		
BT100PK	Pink		
BT100YL	Yellow		

4/3 Slider Gloves

Are you tired of fighting with your old gloves? Slide your hands into a pair of 4/3 Sliders and find out for yourself how easy it is to put on these gloves. The 4/3 Slider uses premium super-stretch neoprene covered with a tight-weave jersey. The result speaks for itself.

- Dual thickness
 - 4 mm neoprene on the back for added warmth
 - 3 mm neoprene on the palm side for dexterity
- Seams are glued and blind stitched for warmth
- Reinforced fingertips for increased durability
- Customer friendly packaging



Part #	Size	Description	Retail
GV430-XS	X-Small	4/3 Slider Gloves	49.00
GV430-SM	Small		
GV430-MD	Medium		
GV430-LG	Large		
GV430-XL	X-Large		
GV430-2XL	2X-Large		

Bug Grabber Gloves

Are you tired of wearing through the fingers on your gloves? The Bug Grabber Gloves use real Kevlar® to cover the palms and wrap around the thumb and fingertips. The 2 mm thick neoprene strikes the perfect balance between warmth and dexterity.

- Perfect glove for lobster diving
- 2 mm neoprene with Kevlar® palm
- Kevlar® wrapped thumb and fingertip design
- Adjustable hook-and-loop wrist closure
- Customer friendly packaging



Part #	Size	Description	Retail
GV100-XS	X-Small	2 mm Bug Grabber Gloves	58.00
GV100-SM	Small		
GV100-MD	Medium		
GV100-LG	Large		
GV100-XL	X-Large		
GV100-2XL	2X-Large		

Touch Gloves

A unique concept in dive gloves which allows the diver to temporarily expose their thumb and forefinger to engage push buttons on wrist top computers, watches, GoPros™ and cameras. The wide, adjustable hook-and-loop wrist closure is removable so you can add a computer or watch in its place.

- Retractable fingertip and thumb caps expose the finger and thumb to operate your dive computer or camera
- Wide gauntlet makes it easy to put on
- 3 mm thickness
- Customer friendly packaging



Part #	Size	Description	Retail
GV450-XS	X-Small	3 mm Touch Gloves	49.00
GV450-SM	Small		
GV450-MD	Medium		
GV450-LG	Large		
GV450-XL	X-Large		
GV450-2XL	2X-Large		

Sonar Gloves

Warmth and comfort are what the Sonar gloves are all about. The wide gauntlet coupled with the stretchy neoprene make them easy to get on and off.

- Available in 3 mm and 5 mm thicknesses
- Pre-bent fingers for natural comfort
- Wide gauntlet makes it easy to put on
- Wide, adjustable hook-and-loop wrist closure
- Customer friendly packaging



Part #	Size	Description	Retail
GV300-XS	X-Small	3 mm Sonar Gloves	41.00
GV300-SM	Small		
GV300-MD	Medium		
GV300-LG	Large		
GV300-XL	X-Large		
GV300-2XL	2X-Large		
Part #	Size	Description	Retail
GV500-XS	X-Small	5 mm Sonar Gloves	43.00
GV500-SM	Small		
GV500-MD	Medium		
GV500-LG	Large		
GV500-XL	X-Large		
GV500-2XL	2X-Large		

Hydra Gloves

A must have glove for your next tropical trip.

- 2 mm super stretch neoprene
- Durable reinforced Amara palm and fingers
- Wide, adjustable hook-and-loop wrist closure
- Improved customer friendly packaging



Part #	Size	Description	Retail
GV250-XS	X-Small	2mm Hydra Gloves	33.00
GV250-SM	Small		
GV250-MD	Medium		
GV250-LG	Large		
GV250-XL	X-Large		
GV250-2XL	2X-Large		

Dry Five Gloves

No more cold hands while diving! The Dry Five gloves are 5 mm thick and our warmest gloves ever. Inner cuff goes under your wetsuit and outer cuff goes over the wetsuit to minimize water entry.

- The ultimate cold water gloves
- Glued and blind stitched seams
- Seams are liquid-taped for a waterproof seam
- Made from our finest 5 mm neoprene
- Twin cuff design for minimal water transfer
- Includes mesh bag packaging



Part #	Size	Description	Retail
GV400-XS	X-Small	5 mm Dry Five Gloves	72.00
GV400-SM	Small		
GV400-MD	Medium		
GV400-LG	Large		
GV400-XL	X-Large		
GV400-2XL	2X-Large		

Spandex Glove Liners

- Take the effort out of putting on your gloves
- Reduce drag on wrists when putting on a wetsuit
- 6 ounce, four-way stretch spandex
- Two sizes: One size to fit most men's hands
One size to fit most women's hands
- Not designed to be worn without gloves as abrasion will cause premature wear



Part #	Description	Retail
GV120-MEN	Spandex Glove Liners	15.00
GV120-WOMEN		



Used with permission by info@divethecave.com

KANA 3/2 and 5 MM Full Suit

Kana is a line of women's and men's wetsuits that will enhance your comfort and pleasure in the water. Available in either 3/2 mm or 5 mm thicknesses, Kana brings you the necessary warmth to maximize your fun.

Comfortable

- Made from premium superstretch fabrics, the Kana suits slide on nicely and peel off easily
- Tailored specifically for a diver's or snorkeler's streamlined swimming position to prevent binding and chafing
- Patterns were created to minimize seams for maximum stretch and warmth
- The 3/2 mm suits have flat-lock stitching for maximum comfort, while the 5 mm suits are glued and blind stitched for increased warmth

Smart

- A finger loop at the base of the zipper assists the user in zipping up their own suit
- Before removing the suit, a clever neck closure allows the user to fold the hook tab over, on to the adjacent loop, so that the hook will not snag and damage other parts of the suit

Durable

- Supratex kneepads bring excellent abrasion resistant properties to this normally high-wear area
- The area beneath the zipper, a common weak point, is reinforced with a rubber patch

Stylish

- Contemporary color combinations
- Custom zipper leashes
- Sharp graphics



Size Chart available in the back of the Price List

Part #	Size	Description	Retail
MS320-SM	Small	Men's Kana 3/2 mm Full Suit	209.00
MS320-MD	Medium		
MS320-LG	Large		
MS320-XL	X-Large		
MS320-2XL	2X-Large		
MS320-3XL	3X-Large		
MS320-4XL	4X-Large		
WS320-XS	X-Small	Women's Kana 3/2 mm Full Suit	209.00
WS320-SM	Small		
WS320-MD	Medium		
WS320-LG	Large		
WS320-XL	X-Large		
WS320-2XL	2X-Large		
MS500-SM	Small	Men's Kana 5 mm Full Suit	297.00
MS500-MD	Medium		
MS500-LG	Large		
MS500-XL	X-Large		
MS500-2XL	2X-Large		
MS500-3XL	3X-Large		
MS500-4XL	4X-Large		
WS500-XS	X-Small	Women's Kana 5 mm Full Suit	297.00
WS500-SM	Small		
WS500-MD	Medium		
WS500-LG	Large		
WS500-XL	X-Large		
WS500-2XL	2X-Large		

Used with permission by info@diver

FATHOM

7 mm Full Suit

Fathom is a men's 7mm one-piece full wetsuit, with back zipper, built to keep the adventure going even when the water is chilly. The Fathom is built for comfort, warmth, and durability by incorporating the following features:

- 7 mm premium neoprene throughout for increased warmth
- Abrasion resistant Supratex fabric used on the butt and knees, which are normally high-wear areas
- Superstretch panels used in the construction of the legs and sleeves aid the diver in putting on the suit
- Heavy-duty #10 YKK zipper is backed by a cold-water zipper dam
- Adjustable skin-in neck panel for optimal comfort
- Before removing the suit, a clever neck closure allows the user to fold the hook tab over, on to the adjacent loop, so that the hook will not snag and damage other parts of the suit
- The Fathom's patterns were created to minimize seams to achieve maximum stretch and warmth
- The area beneath the zipper, a common weak point, is reinforced with a rubber patch
- A finger loop at the base of the zipper assists the user in zipping up their own suit

Size Chart available in the back of the Price List



Part #	Size	Description	Retail
MS710-SM	Small	Fathom 7 mm Full Suit	374.00
MS710-MD	Medium		
MS710-LG	Large		
MS710-XLS	X-Large Short		
MS710-XL	X-Large		
MS710-2XL	2X-Large		
MS710-3XL	3X-Large		395.00

DUO CLASSIC

7 MM Combo Suit

Are you still feeling the chill with a 7 mm one-piece wetsuit? Then it's time to layer up with a step-in Duo Classic. Surround your torso with 14 mm of soft and comfortable neoprene. Donning the suit is made easier with a double shoulder entry farmer john followed by a step-in jacket. Maximize your time and enjoyment in the water with a Duo Classic.

- Easy donning and doffing step-in jacket design
- Farmer john bottoms open at both shoulders using wide hook-and-loop fasteners. This makes for an easy entry as well as providing adjustability to varying torso lengths
- A spine pad in the farmer john fills in the indentation in the center of the diver's back. This prevents flushing while providing additional padding protection from the hard cylinder
- Front diagonal, heavy-duty #10 zipper closure
- Built with soft and comfortable premium nylon-II neoprene
- Superstretch panels are used on the wrists and lower legs to assist in getting hands and feet through the sleeves and legs of the suit
- All seams are glued and blind stitched for warmth and durability
- Supratex knee pads for extended wear
- Lycra trimmed edges for durability

Size Chart available in the back of the Price List



Part #	Size	Description	Retail
MS760-MD	Medium	Duo Classic 7 mm Combo Suit	429.00
MS760-LG	Large		
MS760-XLS	X-Large Short		
MS760-XL	X-Large		
MS760-2XL	2X-Large		
MS760-3XL	3X-Large		
MS760-4XL	4X-Large		450.00

3/2 mm Shorty Suit

Perfect for Tropical Snorkeling

The 3/2 Shorty Suit, the ideal suit for tropical skin and scuba diving, represents a tremendous value. Take inventory of its many features and compare them to the price, and you will see what makes this suit so popular at tropical destinations around the globe.

- 3 mm large panels for warmth, 2 mm key panels for stretch and comfort
- "Skin" seals on the neck, arms and thighs to minimize water transfer
- Water dam behind the zipper
- "Skin-out" chest panel reduces chill in the wind
- Heavy-duty #10 corrosion-free zipper reinforced at the bottom with nylon web and rubber anchor pad
- Flat-lock seam construction for comfort and durability
- Adjustable neck for better fit

Size Chart available in the back of the Price List



Part #	Size	Description	Retail
MS200BK-SM	Small	3/2 mm Shorty Suit	94.00
MS200BK-MD	Medium		
MS200BK-LG	Large		
MS200BK-XL	X-Large		
MS200BK-2XL	2X-Large		
MS200BK-3XL	3X-Large		106.00
MS200BK-4XL	4X-Large		

Rash Guards

When it comes to rash guards, the details are what matter most. Therefore, we add thumb loops to make it easier to get the rash guard sleeve through the wetsuit sleeve. Our design attaches the collar with an external overlock stitch that won't chafe your neck and allows the collar to stretch comfortably over your head. Finally, we use an upgraded 8 oz heavy duty elastane blend with a SPF rating of 50 for maximum durability and protection

- Heavy duty 8 oz material for added warmth and durability
- True 4-way stretch provides comfort and flexibility
- Easier on and off of wetsuit
- Prevent sun burn while snorkeling
- Sun protection factor (SPF) of 50
- External over-lock stitch on the neck prevents chafing and allows the collar to stretch over your head
- Thumb loops make it easy to get your rash guard sleeve through your wetsuit sleeve without bunching up



Size Chart available in the back of the Price List

Part #	Description	Size	Retail
RH303	Women's Blue Hibiscus Long Sleeve Rash Guard	Small	45.00
RH305		Medium	
RH307		Large	
RH309		X-Large	
RH405	Men's Midnight Harbor Long Sleeve Rash Guard	Medium	45.00
RH407		Large	
RH409		X-Large	
RH411		2X-Large	

benthic

COMPRESSION SHORTS

Maintain your modesty without fighting the ride-up that traditional swim trunks cause. As divers, we place much thought into our exposure suits, but do we give consideration as to what to wear under them? Benthic Compression Shorts are the perfect wetsuit undergarment for men.

- 4-way stretch
- Chafe-free flatlock seam construction prevents irritation
- Elastic waistband for secure, comfortable fit
- Durable with supportive fit



Part #	Size	Description	Retail
MS110BK-SM	Small	Benthic Shorts	45.00
MS110BK-MD	Medium		
MS110BK-LG	Large		
MS110BK-XL	X-Large		
MS110BK-2XL	2X-Large		



Neoprene Pocket Shorts

- Fits over wetsuit or drysuit
- Advanced "bike shorts" pattern
- 2 mm superstretch neoprene
- Durable flat-lock seams
- Nylon cord draw string to prevent slipping
- Two Tech Thigh Pockets (see features for HL106)

- Quickly Add Tech Pockets to Your Dive
- Pull These Over your Wetsuit or Drysuit

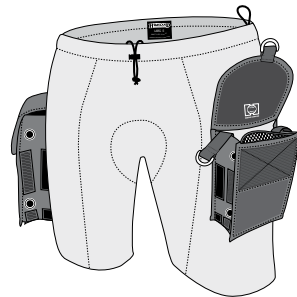

Part #	Description	Size	Waist Size	Retail
HL101-SM	Neoprene Pocket Shorts	Small	25 in to 29 in	143.00
HL101-MD		Medium	29 in to 33 in	
HL101-LG		Large	33 in to 37 in	
HL101-XL		Extra Large	37 in to 41 in	



Glue-On Thigh Pocket

Superior Design and Construction

- 1680D ballistic nylon material
- (3) 1 in (25 mm) stainless steel D-rings per pocket
- Interior mesh divider for Wet Notes (see pg. 156)
- Pleated pockets fold flat with hook-and-loop tabs when not in use
- Nickel coated brass grommets for draining/drying
- Comes with 3/4 oz (21 g) tube of Aquaseal™ and application brush

Dimensions

9 x 6 x 3 in
23 x 15 x 7.5 cm

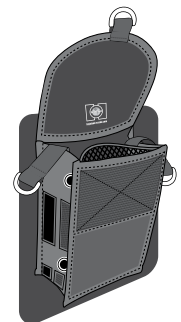

Part #	Description	Retail
HL106	Highland Glue-On Thigh Pocket	55.00

Glue-On Thigh Pocket

- Plenty of room for your spare mask, finger spools, back-up light, etc.
- Ready for gluing to your drysuit or wetsuit
- 0.75 oz Aquaseal™ and application brush included
- Deep bellowed pocket with hook-and-loop closure
- Neoprene back panel
- Interior mesh divider
- Nickel plated brass grommets on bottom & sides



Dimensions
8 x 6 x 2 in
20 x 15 x 5 cm



Back



Front

Part #	Description	Retail
AC430	XS Scuba Glue-On Thigh Pocket	34.00

Tropic Beanie

- Conserve body heat without giving up freedom
- 2 mm neoprene
- Flat-lock construction for durability
- Comfortable, easy to adjust chin strap



Part #	Size	Description	Retail
HD200-SM	Small	2 mm Tropic Beanie	33.00
HD200-MD	Medium		
HD200-LG	Large		
HD200-XL	X-Large		
HD200-2XL	2X-Large		

6 mm Standard Hood

- Glued and double blind stitched construction
- Superstretch neoprene neck for comfort
- Face seal design allows for easy trimming
- Cut away bib for use with drysuit
- 6 mm neoprene hood
- 3 mm "skin-in" neoprene face seal
- 3 mm large, broad bib



Part #	Size	Description	Retail
HD600-SM	Small	6 mm Standard Hood	41.00
HD600-MD	Medium		
HD600-LG	Large		
HD600-XL	X-Large		
HD600-2XL	2X-Large		



Basic Wetsuit Hanger

More Surface Area Equals More Support

- Wider 1.4 in (3.6 cm) support beams
- Sturdy one-piece construction
- Tough X-beam design
- Weight: 5 oz (142 g)



Dimensions
16.6 x 10.4 x 1.4 in
42 x 26.5 x 3.5 cm

Part #	Description	Color	Retail
AC540BK	Basic Wetsuit Hanger	Black	14.00
AC540BU		Blue	
AC540YL		Yellow	

Basic BC Hanger

Hold a BC and Regulator on One Hanger

- Lower hooks hold a regulator by the hoses
- Wide 1.0 in (2.5 cm) support beams
- Sturdy one-piece construction
- Tough X-beam design
- Weight: 5 oz (142 g)



Dimensions
15.8 x 9.8 x 1.0 in
40 x 25 x 2.5 cm

Part #	Description	Color	Retail
AC550BK	Basic BC Hanger	Black	14.00
AC550BU		Blue	
AC550YL		Yellow	

X5 Accessory Hanger

Add This One to Your Student Starter Kits

- Hang em up...mask, snorkel, fins, boots & gloves
- Drain, dry and store in one place
- Removable crossbar to hang mask & snorkel
- Lays flat for travel by removing crossbar
- Tough X-beam design
- Weight: 15 oz (425 g)



Dimensions
16.25 x 17.75 x 5.25 in
41.2 x 45 x 13.5 cm

Part #	Description	Color	Retail
AC500BK	X5 Accessory Hanger	Black	19.00
AC500BU		Blue	
AC500YL		Yellow	

Foldable Drysuit Hanger

Meet our Foldable Drysuit Hanger — the ultimate solution for organized gear management. Hang your drysuit upside-down by the feet to ensure excellent drainage. With a swivel attachment hook, tough X-beam design, Yoke and DIN regulator connections, this hanger adapts to your needs. Fold it flat for travel and utilize the hooks on the sides and front for convenient gear storage.

- Excellent drainage & drying
- Swivel attachment hook
- Tough X-beam design
- Folds flat for convenient storage and travel
- On the outer edge, there are regulator connections for both yoke and DIN regulators
- Hooks along both sides hold regulator hoses or other accessories
- Large hook on the front of the hanger to hold additional accessories
- Weight: 1 lb 1.3 oz (490.5 g)



Part #	Description	Color	Retail
AC515	Foldable Drysuit Hanger	Black	16.50

Travel Wetsuit Hanger

Folds Compact for Travel and Storage

- Unique folding design is ideal for travel
- Broad arms to support the shoulders of wetsuit
- Two additional folding arms for accessories
- Swivel attachment hook
- Tough X-beam design
- Weight: 17 oz (482 g)

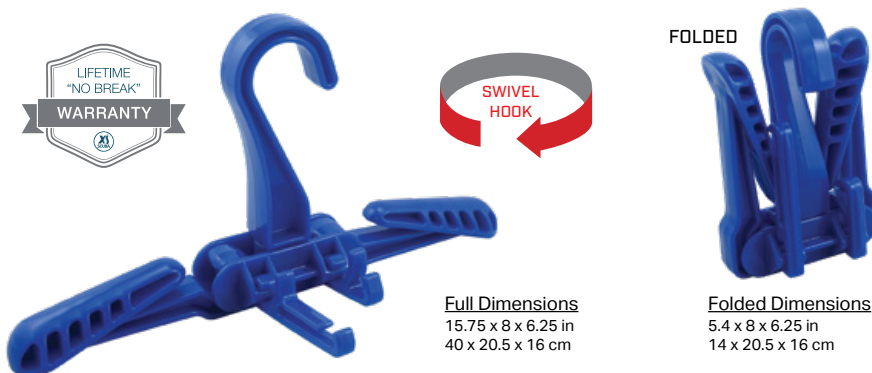

Part #	Description	Color	Retail
AC530BK	Travel Wetsuit Hanger	Black	19.00
AC530BU		Blue	
AC530YL		Yellow	

Travel BC Hanger

Folds Compact for Travel and Storage

- Unique folding design is ideal for travel
- Large hooks to retain the shoulders of BC
- Two additional folding arms for accessories
- Swivel attachment hook
- Tough X-beam design
- Weight: 11.5 oz (326 g)

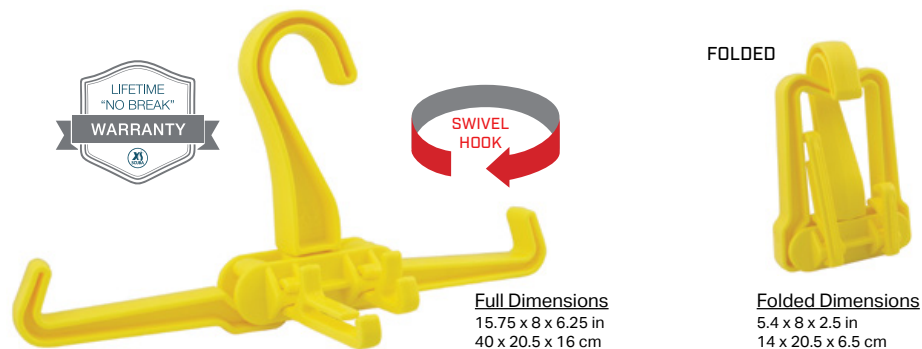

Part #	Description	Color	Retail
AC520BK	Travel BC Hanger	Black	19.00
AC520BU		Blue	
AC520YL		Yellow	

Neuro Knife - Titanium

If you're tired of your knife corroding or losing its edge, upgrade to the Neuro Titanium. Titanium alloy has a very high tensile strength and toughness (even at extreme temperatures). It is light in weight, and has extraordinary corrosion resistance.

- 4.5 in (114 mm) titanium alloy blade
- Available with either clip point or blunt tip design
- The line notch cutter is ideal for cutting monofilament line
- The two-inch serrated edge along back of blade is great for cutting rope
- Full tang runs the length of the handle for strength and rigidity
- Tang protrudes out the back to provide a hammering function
- Self-locking sheath provides an audible "click" to confirm knife engagement
- Attachment point on back of handle for added security
- Includes two 22 in (560 mm) long rubber leg straps with quick release buckles

WARNING: Blunt tip models are made for chiseling and light prying. Prying with too much force can cause knife breakage and injury!



Part #	Description	Blade Style	Retail
KN700	Neuro Knife - Titanium	Clip Point	110.00
KN710		Blunt Tip	
KP10	Replacement Sheath	---	16.00

Neuro Knife - 304 Stainless Steel

The Neuro Knife is a great entry level model that every new diver should carry. The Neuro has excellent ergonomics, feeling comfortable in the hand while being easy to add and remove from the sheath.

- 4.5 in (114 mm) 304 stainless steel blade
- The black model (only) includes a blade with black chromium coating
- Comes standard with a clip point style blade with line notch cutter
- The two-inch serrated edge along back of blade is great for cutting rope
- Full tang runs the length of the handle for strength and rigidity
- Tang protrudes out the back to provide a hammering function
- Self-locking sheath provides an audible "click" to confirm knife engagement
- Attachment point on back of handle for added security
- Includes two 22 in (560 mm) long rubber leg straps with quick release buckles



Part #	Color	Description	Blade Style	Retail
KN750BK	Black	Neuro Knife - 304 Stainless	Clip Point	49.00
KN750BU	Blue			
KN750GY	Grey			
KN750YL	Yellow			
KP10		Replacement Sheath	---	16.00

Stryker Knife - 420 Stainless Steel

The Stryker knives strike the perfect balance between corrosion resistance and the ability to hold an edge. The 420 stainless steel blade is harder, and therefore holds an edge better, than a less expensive 304 stainless model. This results in a sharper knife, one that you can rely on in an entanglement situation.

- The 4.75 in (121 mm) blade is available in either a clip point or blunt tip design
- The two-inch serrated edge along back of blade is great for cutting rope
- The line notch cutter is ideal for cutting monofilament line
- Enlarged guards prevent the hand from slipping forward onto the blade
- Full tang runs the length of the handle for strength and rigidity
- The butt cap on the back provides a hammering function
- An attachment hole runs through the butt cap
- Includes two 22 in (560 mm) long rubber leg straps with quick release buckles

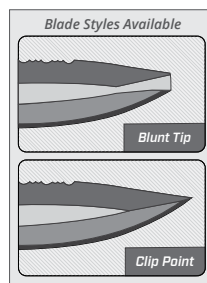

Overall Length
9.75 in (248 mm)

WARNING: Blunt tip models are made for chiseling and light prying. Prying with too much force can cause knife breakage and injury!

Part #	Description	Blade Style	Retail
KN300	Stryker Knife	Clip Point	66.00
KN350		Blunt Tip	
KP01	Replacement Sheath	---	16.00

Rook Knife

Compact knives, like the Rook, lend themselves to a variety of mounting locations. Though small in size, it remains very effective at removing entanglements. Monofilament, nets and kelp are no match for its sharp blade.

- Compact, low-profile backup knife
- Rust-free 304 grade stainless steel
- Modified blunt tip 2.75 in (70 mm) blade
- Advanced serration and line cutter
- Easy release, positive-locking sheath
- Five versatile options for mounting
 - Hose mount to Miflex HP hose (8 mm)
 - Hose mount to rubber HP or LP hose (13 mm)
 - Hose mount to Miflex LP hose (13 mm)
 - Mount to BC / harness, thumbscrews included
 - Attach to leg or arm (0.75 in (19 mm) wide straps not included)

Mount to BC Pocket or Harness Webbing



Rook Knife Includes

A, J Std Hose Mount Insert B, J Miflex Hose Mount Insert C, J Hose Mount Plate
D, J Two Thumbscrews E, J Four Mounting Screws

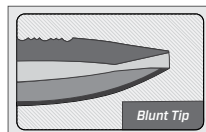
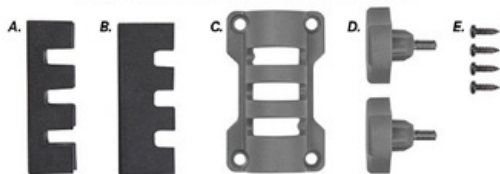

Mount to
Standard Rubber
High Pressure Hose

Mount to
Miflex
High Pressure Hose

Overall Length
6.25 in (159 mm)

Part #	Description	Blade Style	Retail
KN500	Rook Knife	Modified Blunt Tip	48.00
KP08	Replacement Sheath & Mounting Hardware		20.00

FogCutter X Knife

This ingenious knife is actually three tools in one. Not only is it an effective, sharp knife, it also has sharp scissors and a serrated pipe grip integrated into it. The scissors are very effective for cutting monofilament, loose threads on wetsuits, excess webbing on harnesses and belts, just to name a few. The pipe grip can twist a stubborn nut or bolt. Get more work out of your dive knife with the FogCutter X.

- 4.75 in (121 mm) blade
- The 420 stainless steel blade is hardened to hold the edge longer
- Serrated edge along back of blade
- A serrated pipe grip integrated into the handle is ideal for twisting stubborn items
- A butt cap, with attachment hole, located on the back, provides a hammering function
- Includes two 22 in (560 mm) long rubber leg straps with quick release buckles

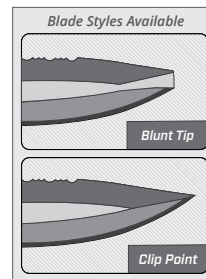

Overall Length
9.5 in (241 mm)

Part #	Description	Blade Style	Retail
KN100	FogCutter X Knife	Clip Point	99.00
KN150		Blunt Tip	
KP01	Replacement Sheath	---	16.00

FogCutter Recon Knife

This is the FogCutter used by Special Ops teams and First Responders around the world. The extra-long cutting edge, coupled with a spear point tip, adds to its functionality. This knife gets the job done when many others cannot.

- The 6 in (152 mm) blade terminates in a spear point tip
- The Recon version has a black-oxide finish
- The 420 stainless steel blade is hardened to hold the edge longer
- Serrated edge along back of blade
- A serrated pipe grip integrated into the handle is ideal for twisting stubborn items
- A butt cap, with attachment hole, located on the back, provides a hammering function
- Includes two 22 in (560 mm) long rubber leg straps with quick release buckles



Overall Length
11 in (280 mm)

Part #	Description	Blade Style	Retail
KN200	FogCutter Recon Knife	Medium Point	120.00
KP02	Replacement Sheath	---	16.00

Mini FogCutter Knife

This smaller version of the FogCutter is the most popular model of them all! The compact size lends itself to multiple mounting options including hose mount, BC mount and webbed harness mount.

- The 3.25 in (83 mm) blade sports a snub-nosed, blunt tip
- The 420 stainless steel blade is hardened to hold the edge longer
- The serrated edge along back of blade is great for cutting rope
- A serrated pipe grip integrated into the handle is ideal for twisting stubborn items
- A butt cap, with attachment hole, located on the back, provides a hammering function

Hose Mount Installed
Fits standard 0.5 in (13 mm) diameter hoses.



Mini FogCutter Knife Includes:

- Hose mount adapter
- Two hook-and-loop straps
- Large mounting plate
- Small mounting plate
- Two thumb screws
- Four mounting screws



Overall Length
6.5 in (165 mm)

Part #	Description	Blade Style	Retail
KN125	Mini FogCutter Knife	Blunt Tip	88.00
KP07	Replacement Sheath & Mounting Accessories		22.00

Black Knight Spearfishing Knife

The Black Knight is an ideal kill knife for dispatching your freshly-speared fish. The stiletto point helps you achieve the precise location on the fish. The razor-sharp edge also comes in handy for cutting kelp and monofilament line.

- All black finish with stiletto tip design
- One-side: serrated edge for cutting of line
- Opposite side: sharp straight edge for precision cuts
- 420 Stainless steel construction
- Chromate treatment for rust-resistance
- "One hand" quick-release sheath with quality rubber straps
- 4 1/8 in (105 mm) blade length



Overall Length
11 in (280 mm)

Part #	Description	Retail
KN600	Black Knight Spearfishing Knife	66.00
KP09	Replacement Sheath & Mounting Hardware	15.00

Neoprene Knife Wrap

- Convenient way to hold your knife sheath
- Neoprene construction with slip-resistant backing
- Adjustable hook-and-loop straps for mounting to lower leg
- Versatile design for use with many different knives



*Knife not included

Part #	Description	Retail
KP04	Neoprene Knife Wrap	24.00

Replacement Knife Straps (Pair)

- 22 in (56 cm) long, adjustable length
- Quick-release buckles
- Black rubber



Part #	Description	Retail
KP03	Replacement Knife Straps (Pair)	11.00

HIGHLAND ENGINEERED QUALITY Titanium Rescue Shears

Rescue Shears have many applications in diving. Whatever your application is, you can be assured that your Highland Rescue Shears are corrosion resistant and offer precision sharpness.

- 420 stainless steel maintains precision sharpness
- The titanium coating provides maximum corrosion resistance
- The hinge bolt is made from rust free 304 stainless steel
- Enhanced serrated lower edge cuts through the toughest materials
- Clothing-lift lip and rounded tip for ultimate patient safety
- Soft-grip, non-slip contoured handles for maximum control even when wet



Dimensions
7.25 x 3.7 x 0.4 in (184 x 94 x 10 mm)

Part #	Description	Retail
HL411	Titanium EMT Shears	23.00
HL425	Titanium EMT Shears with Sheath	29.00
HL421	Optional Sheath for Highland EMT Shears	6.00

LT380 Rechargeable Dive Light

The LT380 Rechargeable is our biggest, brightest, and best light yet! It's penetrating beam distance makes it an ideal choice for a primary light. This 2650 lumen light is powered by two 26650 Li-ion batteries. The tactile 3-way slide switch is easy to manipulate, even with thick gloves.

Come on over to the Dark Side with a LT380!

- Slide switch provides multiple power settings HIGH-MID-OFF
- HIGH is 2650 lumens, MID is 1800 lumens
- Battery duration – 2.5H @ 2650 lumens / 5.5H @ 1800 lumens
- Uses 2 x 26650, 8.4V total, Li-ion rechargeable batteries
- Depth rated to 330 ft (100 m)
- Includes USB battery charging cradle and wrist lanyard
- Comes in a durable, hard-plastic case



Includes Case



Overall Length
8.9 in (225 mm)



Includes Wrist Lanyard and Micro USB Charger

Part #	Description	Retail
LT380	LT380 Rechargeable Dive Light	300.00

LT100 Dive Light

This little powerhouse delivers far more light than you would ever expect from a light this size. Using just 3 AAA batteries, this light can throw up to 300 lumens, which makes it perfect for looking in holes and under ledges by day, or a solid back-up light at night.

- Multi-position button switch HIGH-MID-OFF
- HIGH is 300 lumens, MID is 150 lumens
- Battery duration – 1-hour peak brightness / 7 hrs useable light
- Depth rated to 330 ft (100 m)
- Uses 3 AAA alkaline batteries (not included)

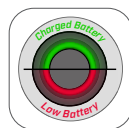
Overall Length
5.22 in (132 mm)

Wrist Lanyard Included

LT100-SH Includes
3.4" SS Shackle

Part #	Description	Retail
LT100	LT100 Dive Light	70.00
LT100-SH	LT100 Dive Light with 3.4" Shackle	88.00

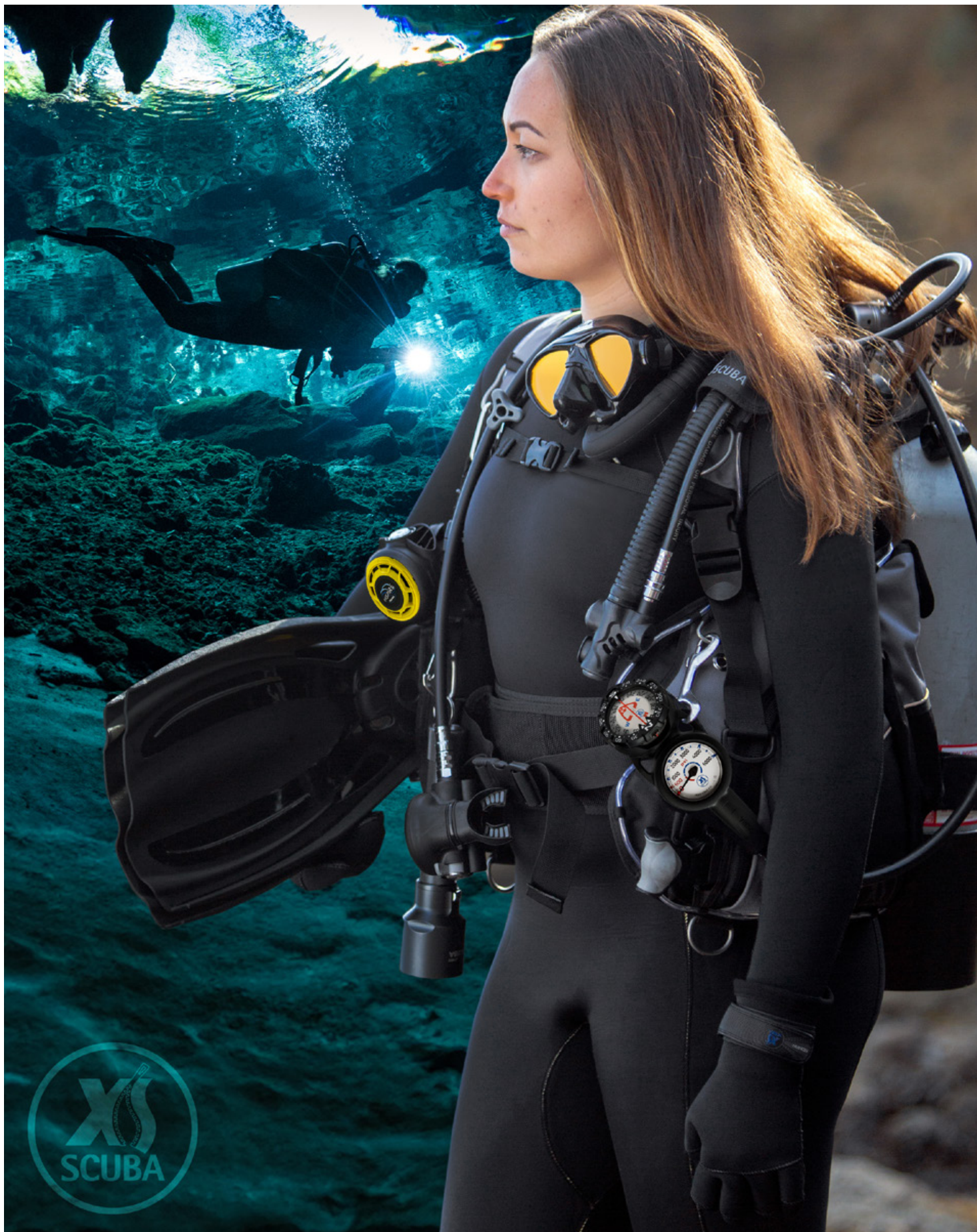

LT300 Rechargeable Dive Light

Don't be fooled by its small size. Powered by the latest CREE XPL-HI V5 LED, this little dynamo casts out a blinding 1000 lumens of light! It is all you need to light up your darkest night dive.

- Multi-position button switch HIGH-MID-OFF
- HIGH is 1000 lumens, MID is 500 lumens
- Battery duration – 1H 10M @ 1000 lumens / 2H 10M @ 500 lumens
- Uses 1 x 18650 2600mAh Li-ion rechargeable battery

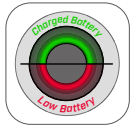

Overall Length
5.0 in (127 mm)



Wrist Lanyard Included



Includes Micro USB charger

Part #	Description	Retail
LT300	LT300 Rechargeable Dive Light	121.00
LT907	18650 Li-ion Battery for the LT300, 4.2V, 2600mAh	22.00
LT925	Charging Cradle for early models, pre-2024	22.00

LT350 Micro USB Rechargeable Dive Light

The LT350 is the ideal rechargeable day time light for looking in holes and under ledges. It also pulls double duty as a night-time back-up light.

- Multi-position button switch HIGH-MID-OFF
- HIGH is 380 lumens, MID is 190 lumens
- Battery duration – 4H @ 380 lumens / 8H @ 190 lumens
- Depth rated to 330 ft (100 m)
- Uses 1 x 18650 2600mAh Li-ion rechargeable battery



Wrist Lanyard Included



Overall Length
6.1 in (155 mm)



LT350-SH - Includes
4" SS Shackle



Includes Micro USB charger

Part #	Description	Retail
LT350	LT350 Micro USB Rechargeable Dive Light	132.00
LT350-SH	LT350 Micro USB Rechargeable Dive Light with 4" Shackle	148.00
LT906	18650 Li-ion Battery for LT350, 4.2V, 2600 mAh	22.00

LT360 Micro USB Rechargeable Dive Light

The LT360 is an excellent primary night diving light. Using 3 CREE LEDs and a wide-angle reflector you will be illuminating a wide field of view.

- Multi-position button switch HIGH-MID-OFF
- HIGH is 1000 lumens, MID is 500 lumens
- Battery duration – 2.3H @ 1000 lumens / 4.5 H @ 500 lumens
- Uses 1 x 26650 5000mAh 4.2V Li-ion rechargeable battery
- Fully charged in 5 hours with Micro USB (DC1A/5.0V)



Wrist Lanyard Included



Overall Length
5.5 in (140 mm)



LT360-SH - Includes
4" SS Shackle



Includes Micro USB charger

Part #	Description	Retail
LT360	LT360 Micro USB Rechargeable Dive Light	192.00
LT360-SH	LT360 Micro USB Rechargeable Dive Light w/ 4" Shackle	209.00
LT905	26650 Li-ion Battery for LT360, 4.2V, 5000 mAh	40.00

LED Glowstick

LED Glowsticks not only provide an added element of safety to your night dive, they save money, and are good for the environment too! Gone are the days of buying and throwing away one-time use plastic, chemical light sticks.

- A long-lasting LED powers fourteen light-emitting fibers that brightly illuminate the glowstick
- SS cable lanyard with SS clip keeps the glowstick secure
- Multiple colors allow you to identify your buddy as well as other divers in your party
- Black chromed brass case with a dual O-ring seal
- Carries a back-up tank valve O-ring for PRO Valve
- Approximate diameter 0.5 in (13 mm)
- Powered by three LR44 alkaline batteries (included)
- Mounting straps makes it easy to mount directly to regulator first stage

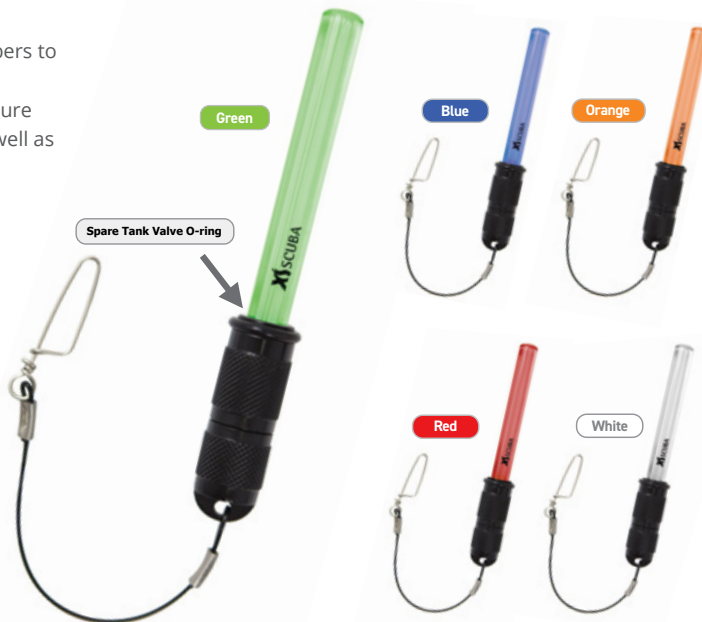

Overall Length
4.5 in (114 mm)

Light Length
3.0 in (76 mm)

Part #	Color	Description	Retail
GS100-BU	Blue	LED Glowsticks	29.00
GS100-GN	Green		
GS100-OR	Orange		
GS100-RD	Red		
GS100-WH	White		
HL309-BA	-	Replacement Mounting Strap Kit - 5 Pieces	11.00

CORALITE

You don't need to spend a small fortune to light your dives. The CORALITE, with its 400 lumens of LED output, is bright enough to light your darkest night dives and useful during the days to peer back into holes and crevices. The lightweight, ABS housing is comfortable in your hand for long durations. The locking switch prevents unintentional activation in your gear bag. Just install 3xAA batteries (not included) and you're ready to go.

Features

- 400 lumen output
- 3.2 hours burn time on HIGH
- 3x AA 1.5V or 3x AA NiMH 1.2V batteries
- Depth rated to 260 ft (80m)
- Locking switch to prevent accidental discharge

Specifications

- Brightness: 400 lumens on high / 40 lumens on low
- Duration: 3.2 hrs on high / 24 hrs on low
- 200 m beam distance
- 7000 lux peak beam intensity
- Weight w/ batteries: 8.5 oz (240g)



Part #	Description	Retail
LT075	CORALITE Dive Light	55.00



Dimensions
36 x 26 x 11 in (91 x 66 x 28 cm)

Universal Floating Object



The UFO is a versatile, floating platform that can be adapted to numerous uses with the addition of customized kits and accessories. Use it for spearfishing, scuba instruction or hookah.

The base model is so feature-rich that do-it-yourselfers will find countless uses for it. There are plenty of tie-downs and attachment points along with ample storage space.

The UFO is rugged. Handles, clips and D-rings are reinforced. The inner bladders are made from thick PVC film and the outer shell is 600D with 4 coatings of polyurethane.

The UFO base model comes standard with a dive flag and staff, shoulder straps, thick foam floor board for rigidity, a crisscross bungee hold-down with tensioner, and enough bungee cord and pull bobs to build 6 tie-downs.

- Rugged construction
 - Outer shell - 600D with 4 coatings of polyurethane
 - Inner bladders - thick PVC film
- 28 attachment D-rings and 12 attachment hooks
- Includes 15 x 12.75 in (38 x 32 cm) dive flag with wire stiffener, staff and mounting hardware
- 2 shoulder straps for hands-free transporting
- Crisscross bungee hold-down with tensioner
- Enough bungee cord and pull bobs to build 6 tie-downs
- 28 in (70 cm) fish measuring scale along starboard side
- Drain holes with SS grommets



Hookah KIT



Instructor KIT

Part #	Description	Retail
UF100	UFO - Universal Floating Object	270.00



Spearfishing and Collecting Kit

The UFO provides many uses to the hunter and gatherer. It will hold all your equipment as well as your catch. It works as a speargun breakaway float for large fish or a chase float. It also works well as a support raft to aid in kicking out to your dive site.

The kit includes: The Anti-Shark Fish Bag, a Collection Bag and a Cargo Net.



Instructor Kit

Finally, an instructor float that does it all! With the installation of the Instructor Kit, the UFO offers plenty of student hand holds as well as secure storage space for instructor slates, spare items and safety equipment.

The kit includes: 2 Handle Assemblies, a zippered Cargo Bag, Cargo Net and a small Folding Anchor.



Hookah Kit

The UFO set up for hookah will be popular with resorts and working divers. The UFO is capable of securely holding the heaviest, large volume cylinders on the surface while the user enjoys freedom of movement down below. We recommend connecting the hookah hose to the UFO bow ring and a pocket weight belt using one of our hose hooks (p/n AC956).

The kit includes: The Tank Carrier with 4 SS clips, a Xplore 1st Stage, 25 ft of Yellow Low-Pressure Hose, 1st Stage Quick Disconnect, 2 ea. Hose Hooks, a Hookah 2nd Stage, a 110° Angle Adapter and a 4-Pocket Zippered Weight Belt.

Part #	Description	Retail
UF150	Spearfishing and Collecting Kit	104.00
UF160	Instructor Kit	88.00
UF170	Hookah Kit	605.00

ACCESSORIES FOR UFO - UNIVERSAL FLOATING OBJECT

Cargo Bag

- Provides secure storage for your important items
- Custom fits into the forward compartment of the UFO
- Corrosion free zipper with large pull bob for use with gloves
- 13 in (33 cm) long x 12 in (30 cm) wide at base x 4 in (10 cm) deep



Part #	Description	Retail
UF200	Cargo Bag	31.00

Cargo Net

- Bungee net stretches across the UFO to secure belongings
- Excellent for wetsuits, towels and other bulky items
- Easily installs by clipping into perimeter hooks



Part #	Description	Retail
UF210	Cargo Net	24.00

Anti-Shark Fish Bag

- Clips to the back of the UFO and hangs in the water
- Rolls up and stays secure with straps until ready to be deployed
- Keep sharks from getting your catch
- Measures 32 in (81 cm) x 20 in (51 cm) when closed



Part #	Description	Retail
UF500	Anti-Shark Fish Bag	62.00

Collection Bag

- Clips to 4 D-rings on the underside of the UFO
- Ideal when freediving for lobster, abalone or scallops
- Drawstring with cordlock cinches the bag closed
- Mesh bag is 39 in (99 cm) in length



Part #	Description	Retail
UF510	Collection Bag	37.00

1.5 lb Folding Anchor

- Compact, folding anchor ideal for UFO
- Rotating collar will lock the 4 tines in either the open or closed position
- Hot dip galvanized finish means no rust
- Weight 1.5 lbs (0.7 kg)



Part #	Description	Retail
UF240	1.5 lb Folding Anchor	20.00

Deluxe Sand Anchor

- 29 in (74 cm) x 15 in (38 cm)
- Extra-strong ½ in (12.5 mm) diameter steel
- 2.5 in (64 mm) diameter auger bit
- Extra-large connection eye will accept most hardware



Part #	Description	Retail
UF245	Deluxe Sand Anchor	55.00

Tank Carrier w/ SS Clips

- Securely attach your cylinder inside the UFO for hookah use
- Includes 4 stainless steel double-ender clips
- Fits cylinder diameters of 6.9 - 8.0 in (175 - 203 mm)
- Convenient handle for carrying cylinder separately from UFO



Part #	Description	Retail
UF300	Tank Carrier w/ SS Clips	74.00

Handle Assemblies (Pair)

- Use this accessory to add 4 perimeter handles to the UFO
- Ideal for class use



Part #	Description	Retail
UF400	Handle Assemblies (pair)	24.00

ADDITIONAL ACCESSORIES FOR UFO - UNIVERSAL FLOATING OBJECT

Part #	Description	Page #	Retail
UF900-C	Spare Bladder - Center	-	23.00
UF900-L	Spare Bladder - Left	-	
UF900-R	Spare Bladder - Right	-	
UF910	Spare Bungee Kit	-	8.00
UF920	Spare Flag Assembly	-	23.00
HL602	Highland Sport Reel - For deploying and retrieving anchor	158	82.00
Various	Hookah Hoses	49	Various
RG310	Hookah 2nd Stage	14	110.00
RG460-01	Xplore 1st Stage only	-	195.00
AC998	First Stage Quick Disconnect	52	77.00
HL502	Mini Tech Gauge	41	44.00
AC956	Hose Hooks - Attach hookah hose to bow ring and diver's belt	49	20.00
AC911	110° Right Angle Adapter - Relieve hose strain on mouth	51	42.00
AC918	LP Hose Splitter - Add a second diver	53	42.00
Various	Pocket Weight Belts	169	Various

RETRACTORS

Grab your gear, use it, let it go – it retracts back every time!



XS Scuba Retractors are not only rugged and dependable, they are designed for harsh salt-water environments. The patented flushing system clears sand, salt and debris. The patented Quick-Connect System provides quick and easy connection / disconnection of the gear.

Features / Models	CL19	CL14	CL13	CL16	CL17	CL18	CL15
Size	Micro	Mini	Mini	Mini	Mini	Standard	Standard
Line/Cable	Spectra®/Nylon	Spectra®/Nylon	Spectra®/Nylon	Spectra®/Nylon	Stainless Steel Cable	Spectra®/Nylon	Spectra®/Nylon
Pull Force	2.5 oz (7 g)	9 oz (255 g)	16 oz (454 g)	9 oz (255 g)	24 oz (680 g)	12 oz (340 g)	24 oz (680 g)
Extension	36 in (91 cm)	32 in (81 cm)	22 in (56 cm)	32 in (81 cm)	18 in (46 cm)	42 in (107 cm)	32 in (81 cm)
Breaking Strength	40 lb (18 kg)	60 lb (27 kg)	60 lb (27 kg)	60 lb (27 kg)	60 lb (27 kg)	80 lb (36 kg)	80 lb (36 kg)
Locking Mechanism	No	No	No	No	No	Yes	Yes

Micro Retractor

- Our smallest and lightest retractor
- Attach to diver with carabiner style snap clip
- Attach to gear with 7/8 in (22 mm) stainless steel split ring
- Recommended for whistles, lobster gauges, slate pencils and small knives



Dimensions
1.5 x 1.3 x 0.4 in
38 x 33 x 10 mm

Part #	Description	Retail
CL19	Micro Retractor	21.00

Mini Retractor

- Mini retractor size
- Attach to diver with Delrin/stainless steel snap hook
- Attach to gear with stainless steel split ring
- Recommended for slates, single computer, and small flashlights (2C to 4AA size)



Dimensions
1.5 x 1.3 x 0.4 in
38 x 33 x 10 mm

Part #	Description	Retail
CL14	Mini Retractor	29.00

HD Mini Retractor

- The CL13 is similar to the popular CL14 Mini Retractor but it sports a larger clip, stronger spring force and less extension
- 1 in (25 mm) snap clip attaches to larger D-rings
- Recommended for medium-sized flashlights (3C to 8AA size)



Dimensions
2.0 x 1.5 x 0.6 in
51 x 38 x 15 mm

Part #	Description	Retail
CL13	HD Mini Retractor	31.00

Console Retractor

- Mini retractor size
- Recommended for small gauge consoles
- Attach to diver with Delrin snap hook or threaded stud
- Attach to console with stainless steel split ring or nylon lanyard



Dimensions
2.0 x 1.5 x 0.6 in
51 x 38 x 15 mm

Part #	Description	Retail
CL17	Console Retractor	37.00

Locking Console Retractor

- Standard retractor size
- Recommended for larger flashlights (3C to 8D size) and cameras
- Lock the cable open, closed or anywhere in the middle
- Recommended for larger gauge consoles
- Attach gear with stainless steel split ring or nylon lanyard



Dimensions
2.6 x 2.2 x 0.8 in
66 x 56 x 20 mm

Part #	Description	Retail
CL15	Locking Console Retractor	43.00

Flashlight / Camera Locking Retractor

- Standard size retractor
- Lock the cable open, closed or anywhere in the middle
- Attach to gear with stainless steel split ring or nylon lanyard
- Attach to diver with Delrin snap hook attachment



Dimensions
2.6 x 2.2 x 0.8 in
66 x 56 x 20 mm

Part #	Description	Retail
CL18	Flashlight / Camera Locking Retractor	39.00

Hose Mount Retractor

- Mini retractor size
- Attachment for hose mount compasses and computers
- Attach to diver with stainless steel split ring or Delrin snap hook



Dimensions
2.0 x 1.5 x 0.8 in
51 x 38 x 20 mm

Part #	Description	Retail
CL16	Hose Mount Retractor	40.00



Coil Lanyard *Delrin Clip/Split Ring & Loop*

- One end has a Delrin / stainless steel wire gate snap hook. The other end has a stainless steel split ring and cord with lock
- These coil lanyards are reinforced with internal stainless steel cable for maximum strength
- Just disengage the side release clip to extend the coil lanyard a full 52 in (132 cm)
- Fastens back to a secure, compact position in seconds
- Excellent for small lights and writing slates



Dimensions
10 in (25 cm)

Part #	Description	Retail
CL01	Coil Lanyard - Delrin Clip/Split Ring	16.00

Coil Lanyard *Stainless Steel Clip/Split Ring & Loop*

- One end has a stainless steel carabiner clip. The other end has a stainless steel split ring and cord with lock
- These coil lanyards are reinforced with internal stainless steel cable for maximum strength
- Just disengage the side release clip to extend the coil lanyard a full 52 in (132 cm)
- Fastens back to a secure, compact position in seconds
- Ideal for use with gauge consoles and medium sized lights



Dimensions
10 in (25 cm)

Part #	Description	Retail
CL02	Coil Lanyard - Stainless Steel Clip/Split Ring	23.00

Coil Lanyard *Stainless Steel Clip Both Ends*

- Both ends have stainless steel carabiner clips
- These coil lanyards are reinforced with internal stainless steel cable for maximum strength
- Just disengage the side release clip to extend the coil lanyard a full 52 in (132 cm)
- Fastens back to a secure, compact position in seconds
- Perfect for camera equipment and large lights



Dimensions
10.5 in (27 cm)

Part #	Description	Retail
CL03	Coil Lanyard - Stainless Steel Clip Both Ends	29.00

Rattle Stick with Magnetic Cap

- Give it a shake to get your buddies attention
- Nice and loud underwater sound
- Built-in attachment clip
- Cap with magnet to prevent unwanted sound



Dimensions
5.5 x 1.0 in
140 x 25 mm

Part #	Description	Retail
AC140C	Rattle Stick with Magnetic Cap	40.00
AC140C-MC	Replacement Magnetic Cap with Lanyard	9.00

Rattle Pointer

- Give it a shake to get your buddies attention
- Use opposite end to point out small critters
- Nice and loud underwater sound
- Built-in attachment clip



Dimensions
13.5 x 1.0 in
343 x 25 mm

Part #	Description	Retail
AC142C	Rattle Pointer	53.00

SS Divemaster Pointer with Snap Clip

- The perfect tool to point out small critters to your group without disturbing them
- Built-in stainless steel swivel clip for easy carrying
- Quick and effective attention getter by tapping on your cylinder
- Rust-free 304 grade stainless steel with heavy 5.5 mm diameter
- Index finger loop for better control

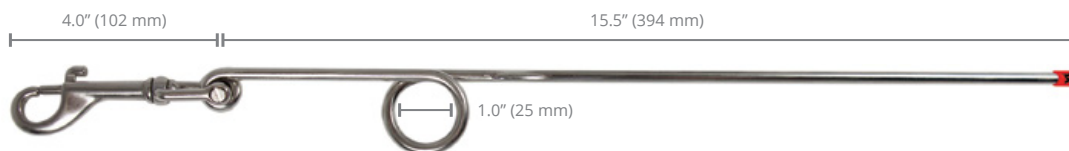

Part #	Description	Retail
AC143C	SS Divemaster Pointer with Snap Clip	27.00

Deluxe Freediving Lanyard

The freediving lanyard is used primarily by vertical line divers. They are often required in freediving classes.

- The deluxe model offers a quick-release, SS, snap-shackle with a "T" pull handle
- 39 in (100 cm) long stainless cable enclosed in a transparent, abrasion-resistant sheath
- Smooth-action swivels on both ends allow safe operation without tangles
- Comfortable, padded wrist cuff with quick release pull tab
- 304 stainless steel spring hook attaches to the 304 stainless steel D-ring when not in use

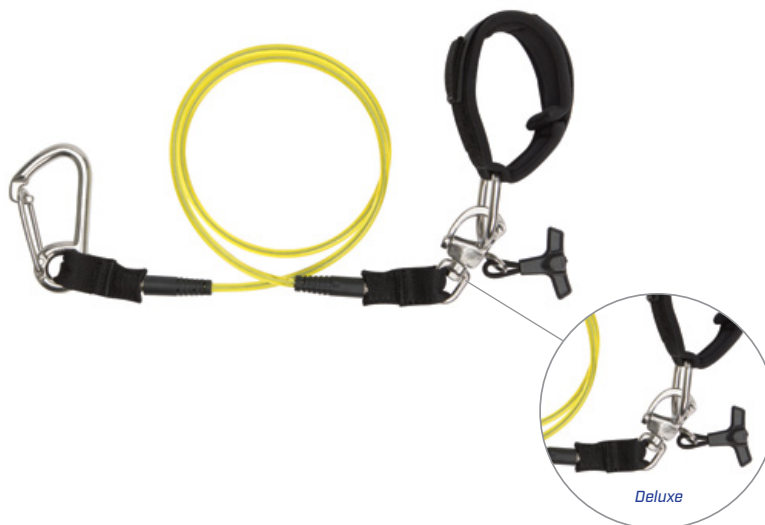

Part #	Description	Retail
AC090	Deluxe Freediving Lanyard	70.00

Dual Color Mouthpieces

- Two material, liquid silicone injection
- Includes traditional mouthpiece tie
- FDA approved material
- Five color combinations
- Individual clamshell packaging



Part #	Description	Retail
AC328GY	Mouthpiece - Black Silicone with Gray Bite Tabs	8.50
AC329BK	Mouthpiece - Black Silicone with Black Bite Tabs	
AC331BU	Mouthpiece - Black Silicone with Blue Bite Tabs	
AC332YL	Mouthpiece - Black Silicone with Yellow Bite Tabs	
AC333RD	Mouthpiece - Black Silicone with Red Bite Tabs	

Comfy-bite Mouthpiece

The Comfy-bite Mouthpiece has a unique bridge that fits across the upper palate. It assists in holding the mouthpiece in place. This prevents clinching and reduces jaw fatigue. Enjoy the secure feeling of the regulator in your mouth.

- Size regular available in both black and clear silicone
- Size small, available in black silicone only, fits youth and smaller individuals
- Attractive clamshell packaging
- Includes nylon tie wrap
- Injected molded from liquid silicone



Part #	Color	Description	Retail
AC336BS	Black Silicone	Comfy-bite Mouthpiece	10.50
AC336CL	Clear Silicone		
AC337BS	Black Silicone	Junior Comfy-bite Mouthpiece	

Extended Tab Mouthpiece

- Excellent comfort with longer tapered tabs
- High quality, liquid silicone injection
- Includes traditional mouthpiece tie
- FDA approved material
- Individual clamshell packaging



Part #	Color	Description	Retail
AC330BS	Black Silicone	Extended Tab Mouthpiece	7.00

Bulk Mouthpieces - Bag of 25

- Bulk pack of 25 mouthpieces
- Simple and economical
- Ideal for rentals and everyday use



Part #	Description
AC335BK	Bulk Pack of Black Rubber Mouthpieces - Bag of 25
AC335BS	Bulk Pack of Black Silicone Mouthpieces - Bag of 25
AC335CL	Bulk Pack of Clear Silicone Mouthpieces - Bag of 25
AC335CB	Bulk Pack of Black Silicone Comfy-bite Mouthpieces - Bag of 25

Scuba Multi-Tool - 9 Tools Each With A Specific Scuba Purpose



Dimensions
2.5 x .75 x 1.4 in
Only 4 ounces

*All tools are stainless steel
except for O-ring pick is bronze*

Part #	Description	Retail
TL110	Scuba Multi-Tool	34.50

Star Tool - Stainless Steel

The Perfect Companion To Our Scuba Multi-Tool

- Remove and replace the most common scuba hoses
- 1/2", 9/16", 5/8" & 11/16" wrenches
- Most common hex wrenches 5/32", 3/16" & 1/4"
- Valve handwheel driver
- All imperial sizes for US products
- Stainless steel construction with silicone over mold



Dimensions
3.85 x 0.5 in thick
98 x 13 mm thick

Part #	Description	Retail
TL127	Stainless Steel Star Tool	46.00

Diver's ToolMaster

- Stainless steel construction
- 6 wrenches: 1/2", 9/16", 5/8", 11/16", 13/16", 15 mm
- 3 screwdrivers: 1/8", 1/4" Flat, #1 Phillips
- 2 Allen keys: 3/16", 5/32"
- 1 scratch awl



Dimensions
4.5 x 1 x 1 in
114 x 25 x 25 mm

Part #	Description	Retail
TL103	Diver's ToolMaster	29.00

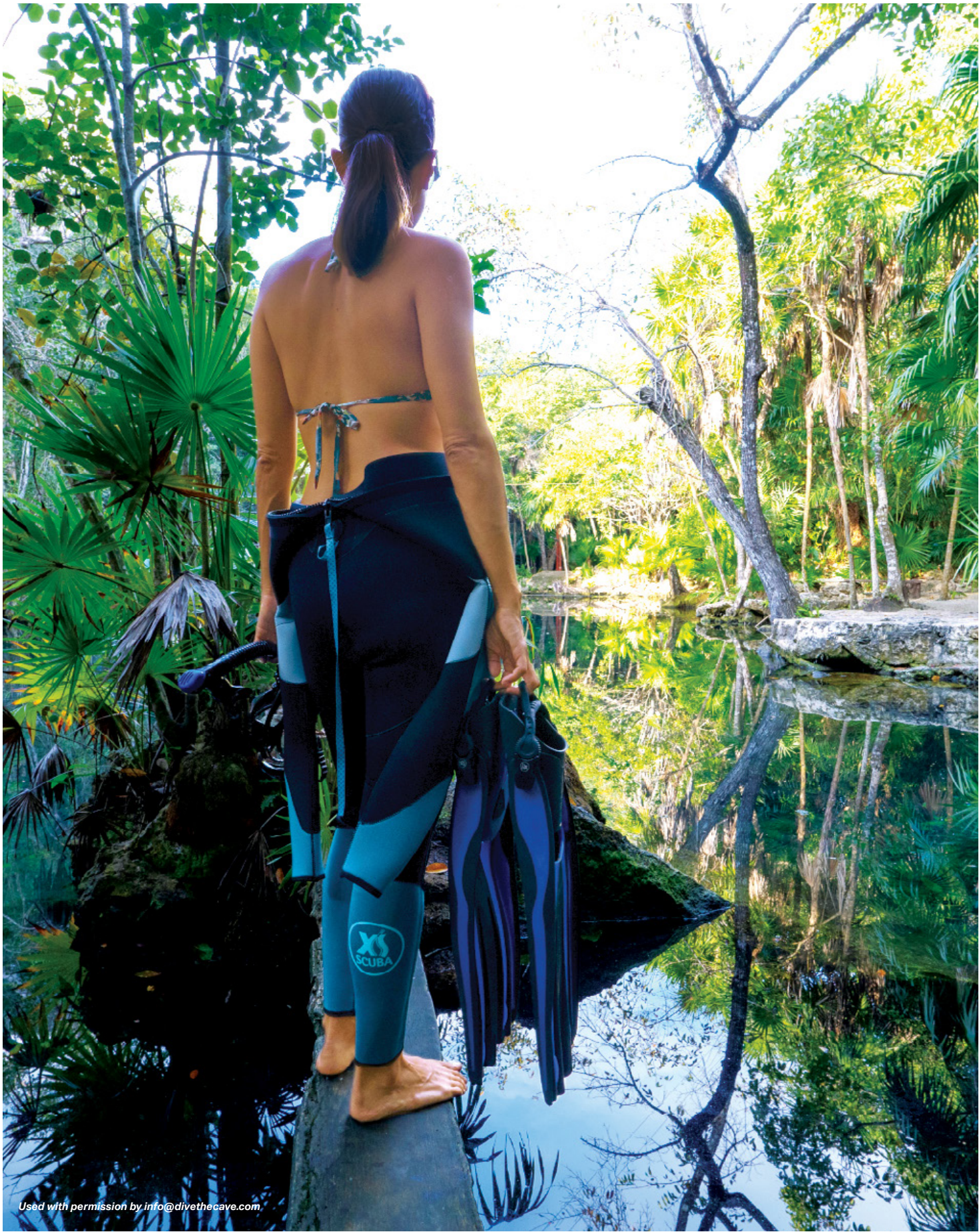

Used with permission by info@divethecave.com

Save-A-Dive Kit

- Watertight plastic box
- Mask strap
- Regulator mouthpiece
- (6) common O-rings
- (3) cable ties
- Snorkel retainer
- Fin strap with buckles
- SS weight keeper



Part #	Description	Retail
AC320	Save-A-Dive Kit	32.00

Pocket Rescue Mask with Case

- Compact emergency ventilation mask
- One-way valve for protection
- Oxygen attachment port for continuous flow
- Includes protective case
- Latex free



Part #	Description	Retail
AC460	Rescue Mask with Case	23.00

Octopus Holder

- Retains octopus by inserting mouthpiece
- Split ring or snap hook attachment
- Helps prevent unwanted freeflow



Part #	Description	Retail
AC340	Octo Holder	6.50

Octopus Holder

An easy way to secure your octopus second stage. Octopus can be removed with a simple, firm tug.

- Includes plastic snap hook for D-ring attachment
- Helps prevent unwanted freeflow upon entry by providing back pressure on the second stage diaphragm
- AC345 is for mouthpieces with traditional bite tabs
- AC350 is dedicated to Comfy-bite mouthpieces



Part #	Description	Retail
AC345	Octo Holder - Standard Mouthpiece	7.00
AC350	Octo Holder - Comfy-bite Mouthpiece	7.00

Wind Storm™ Safety Whistle

The Wind Storm™ whistles outperform all of the other leading brands of whistles. It even works underwater, up to 50 ft (15.25 m).

- Performs in all conditions, in any weather
- Can be heard on land up to ½ mile (804 m) away!
- Can be heard underwater for a distance of up to 50 ft (15.25 m)!
- SOLAS Coast Guard approved



Part #	Description	Retail
AC482	Wind Storm™ Safety Whistle	12.00



Deluxe Wet Notes

Highland Deluxe Wet Notes are an invaluable tool for technical, scientific and recreational divers alike. They allow you to display your dive plan, record your findings, draw your observations and communicate with your buddy. They are compact, convenient and easy-to-use.

- 23 blank, 2-sided wet pages
- 2 blank slates
- Clear, exterior pocket to accommodate slate(s)
- Bungee, attachment lanyard
- Elastic bookmark
- Slots for additional pencils
- Clear pocket inside back cover for additional storage
- Includes custom graphite rod pencil



Dimensions Closed

5.75 x 7.5 in (146 x 190 mm)

Dimensions Open

10.75 x 7.5 in (273 x 190 mm)

Part #	Description	Retail
HL440	Highland Deluxe Wet Notes	43.00
HL441	Replacement Pages For Wet Notes	23.00

Deluxe Folding Slate

- Great folding design
- Sturdy attachment clip
- Unique adjustable lead pencil



Dimensions Closed

5.75 x 7.5 in (146 x 190 mm)

Dimensions Open

10.75 x 7.5 in (273 x 190 mm)

Part #	Description	Retail
AC455	Deluxe Folding Slate	25.00

Folding Wrist Slate

- Designed to fit the curve of a forearm
- Three separate writing surfaces with two fold up leaves
- Graphite stick pencil
- Two methods for attachment included:
Hook-and-loop strap and bungee cords



Dimensions

4.25 x 4.0 in

108 x 102 mm

Part #	Description	Retail
AC456	Folding Wrist Slate	26.00

Replacement Graphite Pencil w/ Lanyard

- Universal design, can work with any slate
- Barb on end of coil fits through 1/8 in (3.5 mm) hole



Part #	Description	Retail
AC454	Replacement Graphite Pencil w/ Lanyard	4.50

Dive Flag / Float Assembly

This Flag/Float Assembly notifies all who see it that there are divers in the vicinity. This float can be anchored for stationary use or trailed behind by a diver. A lead weight on the bottom keeps the assembly vertical while in the water.

- The 4 ft (122 cm) staff comes apart in two pieces for compact storage
- Integrated 11 oz (312 g) lead weight with attachment hole
- Includes 2 flag clips to keep flag secured to the staff
- Accessory D-ring located on the bottom of the float is useful for attaching a small light or slate
- A diagonal wire stiffener keeps the flag fully extended even when the wind is not blowing



Flag Dimensions
12.5 x 15 in (32 x 38 cm)

Part #	Description	Retail
AC040	Float Assembly	44.00



Aluminum Mini Spool with Dyneema® Leader

Aluminum spools are strong, yet lightweight. This 50 ft (15 m) size is practical for most applications, especially deploying surface markers. A Dyneema® leader protects the main line when the line is clipped off near sharp edges.

- Dyneema® leader can take extreme wear and abrasion
- The breaking strength is 400 lbs (181 kg)
- Leader mounted to a stainless steel swivel to prevent twisting of main line
- Main line is flat, braided nylon with 132 lbs (60 kg) breaking strength
- Includes 3.5" SS, double-ender bolt snap
- Flared edges are easier to grip and keep fingers out of the way while winding
- Perfect size for deploying surface markers



Part #	Color	Description	Retail
HL460BK	Black	Highland Alum Spool w/ Dyneema® Leader 50 ft (15.2 m)	84.00
HL460GN	Green		



Flared SS Spools

- Flared edges are easier to grip and keep fingers out of the way while winding
- Large center hole fits gloved thumb
- 304 stainless steel with anodized surface
- #24 orange line, 8 strand, with breaking strength of 168 lbs (76 kg)
- 4" stainless steel double-ender bolt snap with 18-8 SS internal springs



Part #	Description	Length	Diameter	Width	Retail
HL475SS	Flared Stainless Steel Spool	50 ft (15.2 m)	3.3 in (84mm)	1.6 in (41mm)	62.00
HL465SS		100 ft (30.5 m)	3.3 in (84mm)	2.1 in (53mm)	67.00
HL470SS		150 ft (45.7 m)	3.3 in (84mm)	2.5 in (63mm)	72.00

Finger Spools

- Available in three sizes
- Spools are injection-molded with glass-filled nylon
- #24 hi-viz yellow nylon 16 strand line (breaking strength 120 lbs / 55 kg)
- 4" stainless steel double-ender bolt snap with 18-8 SS internal springs



Part #	Description	Length	Diameter	Width	Retail
AC475	Finger Spool	50 ft (15.2 m)	3 in (76mm)	1 in (25mm)	25.00
AC465		100 ft (30.5 m)	3 in (76mm)	1.44 in (36mm)	27.00
AC470		150 ft (45.7 m)	3.25 in (82mm)	1.75 in (44mm)	29.00

HIGHLAND Sport Reel

- Stainless steel frame
- #24 hi-viz yellow nylon 16 strand line
- Breaking strength is 175 lbs (80 kg)
- 4" stainless steel double-ender bolt snap with 18-8 SS internal springs
- Molded carry handle with attachment hole
- Three position switch: Skip / Free / Stop
- 2.75" stainless steel bolt snap with 18-8 SS internal spring attached to handle



Part #	Description	Length	Retail
HL602	Sport Reel	150 ft (45.7 m)	90.00

HIGHLAND Tech Reels

- Solid, one-piece, anodized aluminum handle
- Spool lock can mount on either end for left or right-handed use
- Spool is machined from Delrin, will not warp or absorb water like nylon spools
- Includes 4" SS double-ender bolt snap
- #24 orange line, 8 strand, with breaking strength of 200 lbs (91 kg) nylon



HL200



HL400

Part #	Description	Length	Retail
HL200	Highland Tech Reel	200 ft (61 m)	193.00
HL400		400 ft (122 m)	215.00

Replacement Line

- #24-16 strand - Nylon line
- 2 kilogram spool
- 3,100 feet/945 m (approximate)
- Breaking strength 120 lbs / 55 kg

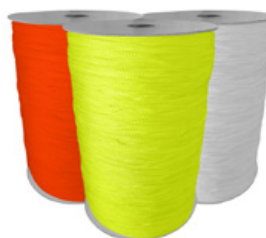

Part #	Color	Description
AC461	International Orange	Spool of Nylon Line
AC462	White	
AC463	Hi-Viz Yellow	

HIGHLAND ENGINEERED QUALITY Jonline

For hands-free safety stops and deco stops.

- 6.5 ft (2m) of type IV high strength paracord
- 316 stainless steel D-rings and 304 stainless Garvin Hook
- Pouch is made of 1680D ballistic nylon
- Modified closure flap allows Garvin Hook to be stowed in the pouch
- Drain grommet in the bottom
- Webbing pass thru on the back



HL424 - Garvin Hook Only

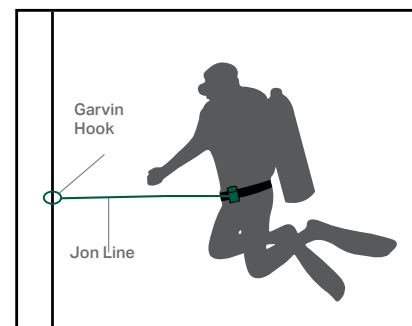

Part #	Description	Retail
HL423	Jonline	37.00
HL424	Garvin Hook	9.00

HIGHLAND ENGINEERED QUALITY Cave Markers [10 Piece Packs]

Highland Cave Markers are strong and highly visible. They are a good value because they are of excellent quality at an affordable price.

- Available in white or glow-in-the-dark
- You can easily write on them with a permanent marker
- All points have been rounded off for ease of use
- Molded from ABS plastic
- Thickness is 0.15 in (3.8 mm)
- Attach perfectly to the Highland Cave Marker Holder (p/n HL935)



HIGHLAND ENGINEERED QUALITY Cave Marker Holder

The Highland Cave Marker Holder is a smart way to safely secure and organize your cave markers. Simply pull the tubing to add or remove your markers. Relax the tubing and the markers are held firmly in place.

- Organized storage – no more hunting for the proper markers in your utility pockets
- Bolt snap made from 316 stainless steel
- Overall length of 7.75 in (19.6 cm) allows plenty of room for all your markers
- Replacement tubing kit available (p/n HL936)

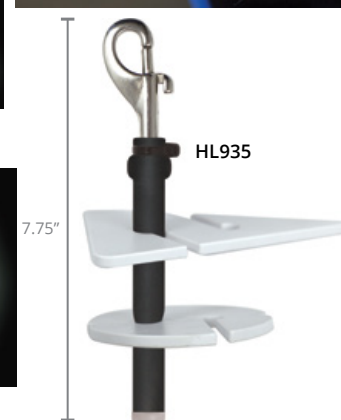
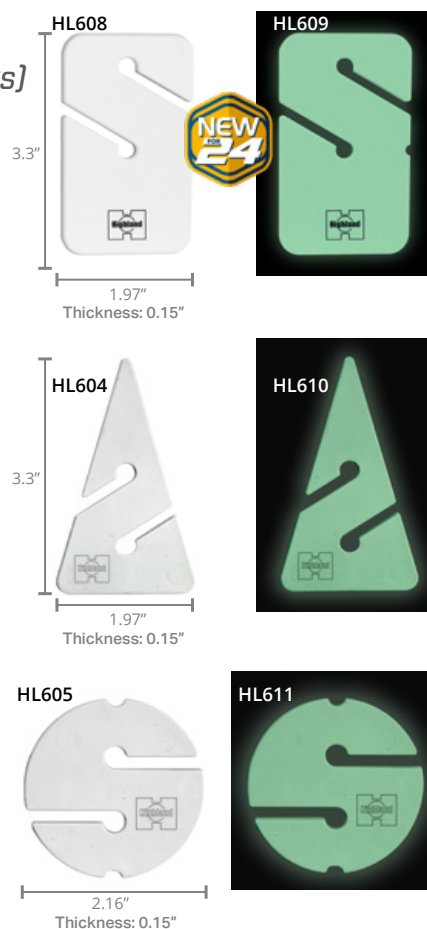
Line arrows and line cookies are sold separately.



Part #	Description	Retail
HL604	Line Arrows - White - 10 Piece Pack	15.00
HL610	Line Arrows - Glow In The Dark - 10 Piece Pack	16.00
HL605	Line Cookies - White - 10 Piece Pack	15.00
HL611	Line Cookies - Glow In The Dark - 10 Piece Pack	16.00
 HL608	Reference Exit Markers - White - 10 Piece Pack	15.00
 HL609	Reference Exit Markers - Glow In The Dark - 10 Piece Pack	16.00
HL935	Cave Marker Holder	18.00
HL936	Replacement Tubing Kit	8.00



SQUALL P O C K E T

The Squall Pocket is perfect for carrying your backup mask. The semi-rigid sides allow the mask to slide right in. An over-sized clip on the front is no match for 5 mm or dry gloves. The Squall is so versatile, it can also carry many types of technical accessories, such as spools, wet notes, and SMBs.

- Made from rugged 1680D nylon
- Tri-fold web loops clamp on to 2 in (50 mm) harness webbing
- A 1 in (25 mm) SS D-ring provides an alternate clip-on option
- Features an over-sized 2 in (50 mm) side-release buckle for easy operation with gloves



Part #	Description	Retail
HL230	Squall Pocket	45.00



Hurricane Pocket

The Highland Hurricane Pocket securely holds your critical accessories. Thanks to two, large zipper pulls of different sizes, you can blindly identify which pocket is which. Internal D-ring attachment points prevent accidental loss of accessories.

- 2 attachment options
 - Tri-fold web loops clamp onto 2 in (50 mm) harness webbing
 - SS D-rings allow attachment to backplate using double-enders
- Made from 1000D nylon for extreme durability
- Different size zipper pulls so you can identify main and accessory pockets w/o looking
- Both compartments have quick water drainage
- Extra wide for reels, spools, SMBs and wet notes

Dimensions

8 x 6 x 3 in
(20 x 15 x 8 cm)



Part #	Description	Retail
HL215	Hurricane Pocket	55.00



Tempest Pocket

The Highland Tempest Pocket securely holds your critical accessories. The large, zippered pocket is ideal for a spare mask, reel, or SMB. The front accessory pocket is ideal for a spool or a jonline. An internal D-ring and loop attachment points prevent accidental loss of accessories.

- 2 attachment options
 - Tri-fold web loops clamp onto 2 in (50 mm) harness webbing
 - SS D-rings allow attachment to backplate using double-enders
- Main zipper up against stiffener panel for one-hand operation
- Made from 1000D nylon for extreme durability



Dimensions

8.25 x 5.5 x 3.5 in
(21 x 14 x 9 cm)

Part #	Description	Retail
HL220	Tempest Pocket	55.00



Zephyr Pocket

The Highland Zephyr Pocket is a spacious utility pocket that securely holds your diving accessories. It features an 18 in (46 cm) internal bungee loop so that you can clip off your accessories and not worry about dropping them while getting them in and out of the pocket.

- 2 attachment options
 - Tri-fold web loops clamp onto 2 in (50 mm) harness webbing
 - SS D-rings allow attachment using double-enders
- Internal attachments
 - Includes 18 in long loop of bungee to secure your accessories
- Made from 1000D nylon for durability

Dimensions

6 x 6 x 2.5 in
(15 x 15 x 6.5 cm)



- Drain grommet in the bottom
- Extra wide for reels, spools, SMBs and wet notes

Part #	Description	Retail
HL225	Zephyr Pocket	33.00

Standard 50 Pound Lift Bag

- Traditional open bottom design
- 50 lbs (23 kg) of positive lift
- Rolls up to compact size
- 316 stainless steel 5 in bolt clip for attachment
- Heavy-duty, PVC material



Dimensions
20 x 20 in
50 x 50 cm

Part #	Description	Retail
AC050	Standard 50 Pound Lift Bag	55.00

Deluxe 50 Pound Lift Bag

- 50 lbs (23 kg) of positive lift
- Anti-spill bottom with baffle to allow easy fill from any second stage
- Combination oral and BC QD inflator
- Remains inflated until you empty it
- 2 in (50 mm) diameter OPV with pull for manual release (p/n BP52)
- Rolls up to compact size and stays closed with hook-and-loop strap
- Elastic loop at top for chemical light attachment
- Stainless steel D-ring at top for slate attachment
- Lifting strap with stainless steel D-ring at bottom



Dimensions
21 x 28.5 in
53 x 72 cm

Part #	Color	Description	Retail
AC060-OR	Orange	Deluxe 50 Pound Lift Bag	77.00
AC060-YL	Yellow		

HIGHLAND ENGINEERED QUALITY 100 Pound Lift Bag

- 100 lbs (45 kg) of positive lift
- "Anti-spill" bottom for easy fill from bottom
- Combination oral/QD inflator hose inflator
- 2 in (50 mm) diameter OPV with pull for manual release (p/n BP52)
- Lifting strap with stainless steel D-ring
- Elastic chemical light holder at top
- Stainless steel D-ring at top for attachment of light or strobe
- Lifting handle at top
- Includes 6.5 x 12 in (16.5 x 30.5 cm) mesh carry pouch with grommets for plate attachment (p/n HL080)
- Mounting hardware is not included (p/n HL510)



Mesh Carry Pouch Included



Dimensions
22.5 x 30.5 in
57 x 77 cm

Part #	Description	Retail
HL203-OR	100 Pound Lift Bag	120.00

HIGHLAND ENGINEERED QUALITY Mesh Carry Pouch

- HL080 fits SMB p/n AC070, and lift bags p/n AC050, AC060, and HL203
- HL085 fits SMB p/n HL202
- Heavy-duty, PVC-coated nylon mesh
- Side-opening hook-and-loop closure
- Five stainless steel grommets for attachment
- Mounting hardware is not included (p/n HL510)



See Page 25

OPENING



Dimensions
6.5 x 12 in
16.5 x 30.5 cm
OR
6.5 x 14 in
16.5 x 35.5 cm

Part #	Description	Retail
HL080	Mesh Carry Pouch 6.5 x 12 in (16.5 x 30.5 cm)	16.00
HL085	Mesh Carry Pouch 6.5 x 14 in (16.5 x 35.5 cm)	18.00
HL510	SS Book Screw - 1 Complete Set	11.00



Technical Marker Buoy

Rebreather, extended range, and sidemount divers have different requirements for a DSMB than recreational divers. From the heavy-duty 420D nylon fabric to the over-sized stainless attachment D-ring on the bottom, this DSMB is a quality product purposefully designed with the technical diver in mind.

- Closed bottom design - 45 in (114 cm) length x 10 in (25.4 cm) circumference
- The stainless steel tipped inflator allows oral or QD hose inflation
- 2 in (5 cm) wide SOLAS reflector tape all the way around
- 2 x 4 in (5 x 10 cm) white panel at the top to write on with a permanent marker
- 1.5 in (38 mm) over-pressure valve with pull cord for easy deflation and roll-up
- 1 in (25 mm) plastic attachment D-ring at the top



Large, 1.5" SS D-ring attachment



SS tipped inflator for durability

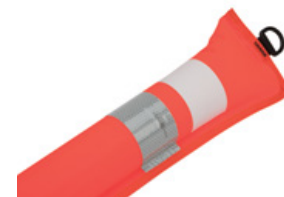

White ID panel and SOLAS reflector

Part #	Description	Retail
HL206	Technical Marker Buoy	66.00



10' Surface Marker Buoy

This expedition quality model is exactly what you want when diving in high seas or areas of heavy boat traffic.

- BIG - 10 ft (3 m) long with 22 in (559 mm) circumference
- Large enough to greatly enhance diver visibility yet compact enough to carry easily
- 75 lb surface lift
- Anti-spill bottom with baffle to allow easy fill from any second stage
- Combination oral and BC QD inflator
- 2 in (50 mm) diameter OPV with pull for manual release
- Three bands of 3M SOLAS reflective tape for improved surface visibility
- Stainless steel D-ring at top for strobe attachment
- 20 in (51 cm) long lift harness with stainless steel D-ring
- Elastic chemical light stick holder at top
- Includes 6.5 x 14 in (16.5 x 36 cm) mesh carry pouch with grommets for backplate attachment (p/n HL085)
- Mounting hardware is not included (p/n HL510)

Optional Mounting Hardware



HL510

See Page 25

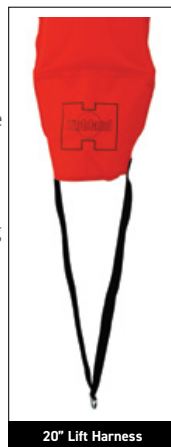

20" Lift Harness



SOLAS Tape



Mesh Carry Pouch Included



Overpressure Relief Valve



Combo Inflator



Part #	Description	Retail
HL202-OR	10' Surface Marker Buoy	135.00
HL510	SS Book Screw - 1 Complete Set	11.00

“Quick Launch” Marker Buoy

Deploying a marker buoy from depth has its challenges. Securing a line spool and SMB, connecting them together, all while maintaining neutral buoyancy and holding on to other gear, has overwhelmed many a diver. The “Quick Launch” Marker Buoy simplifies the procedure! The line spool is stored within the marker buoy and is already connected to it! Just add air and let it fly.

- 6 ft (183 cm) length / large 12 in (30.5 cm) circumference
- Lower pocket includes a spool with 100 ft (30 m) of line
- Spool line is attached to D-ring inside the pocket
- Open bottom with anti-spill baffle
- Combination oral and QD hose inflation
- Over-pressure relief valve with pull cord
- SOLAS reflective tape on both sides



Part #	Color	Description	Retail
AC085-OR	Orange	“Quick Launch” Marker Buoy	99.00
AC085-PK	Pink		
AC085-YL	Yellow		
 AC085-YL/OR	Yellow / Orange		

“Smart Marker” Buoy (SMB)

With so many SMBs in the marketplace, it is easy to become confused. Some are “bare bones” proving difficult to use, while others are overbuilt, more suited for extreme expeditions. The XS Scuba Smart Marker Buoy (SMB) adds all the right features in all the right places. It's the “Smart” choice.

- 6 ft (183 cm) length / large 12 in (30.5 cm) circumference
- Lower pocket accommodates a lead weight or finger spool
- Open bottom with anti-spill baffle
- Combination oral and BC QD inflation
- Overpressure relief valve w/ manual pull cord
- SOLAS reflective tape on both sides

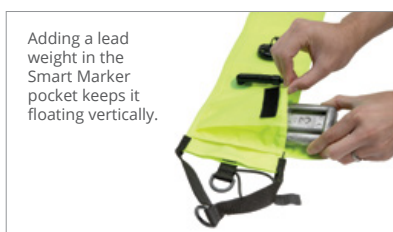

Adding a lead weight in the Smart Marker pocket keeps it floating vertically.



Part #	Color	Description	Retail
AC065-OR	Orange	"Smart Marker" Buoy	80.00
AC065-PK	Pink		
AC065-YL	Yellow		

6' Safety Tube

Lightweight, compact and inexpensive.
Ideal for the openwater student.

- 6 ft (1.8 m) long x 10 in (254 mm) circumference
- Rolls compact to 5 x 3 in (12 x 8 cm)
- Includes mesh bag with snap clip
- SS grommet at top to attach light
- Clip to attach to diver when inflated
- Easy to use oral inflator/deflator



Part #	Description	Retail
AC190	6' Safety Tube	37.00

6' SMB - Surface Marker Buoy

This entry-level model is compact and very easy to deploy and inflate. If quick and easy are the objective, there is none better. Made from 75D urethane backed fabric.

- 6 ft (183 cm) length, closed ends
- High visibility international orange
- Oral inflator with lock down valve
- Elastic retaining loop
- Upgraded wire-gate swivel clip



Part #	Description	Retail
AC075	6' SMB - Surface Marker Buoy	49.00

7' SMB - Surface Marker Buoy

This large, 7 ft (2.1 m) SMB is the one you want when you know that you will be diving in a location known for strong wind and currents.

The large diameter will help keep it vertical in adverse conditions and will be more easily seen by boats.

- 7 ft (2.1 m) long x 15 in (381 mm) circumference, 5 in (127 mm) diameter
- Mil-Spec, urethane backed, nylon material
- SOLAS reflective tape on both sides for maximum visibility
- Elastic loop at top for chemical light attachment
- Stainless steel D-ring at top for slate attachment
- Lifting handle at top of tube
- 2 in (50 mm) diameter over pressure relief valve with pull for manual release
- Combination oral and BC QD inflator
- Anti-spill bottom with baffle to allow easy fill from any second stage
- Lifting strap with stainless steel D-ring at bottom
- 18 in (46 cm) step-thru leg harness with stainless steel D-ring
- 50 lbs (23 kg) of positive lift



Part #	Color	Description	Retail
AC070-OR	Orange	7' SMB - Surface Marker Buoy	99.00

Soft Mesh Weights

- #5 round lead shot
- Hardened with antimony
- Heavy-duty nylon mesh bags
- Double needle stitching
- Colored labels for easy size identification
- Full case quantities only

One pound weight pricing includes a \$0.25 per lb surcharge



Part #	Size	Label Color	Case Quantity	Case Weight
WC01-40	1 lb	Blue	40 units	40 lbs
WC02-20	2 lbs	Red	20 units	40 lbs
WC03-13	3 lbs	Yellow	13 units	39 lbs
WC04-10	4 lbs	Orange	10 units	40 lbs
WC05-8	5 lbs	White	8 units	40 lbs
WC-MIX	Mixed Case	Various	(2) 5#, (3) 4#, (2) 3#, (4) 2#, (4) 1#	40 lbs

Lace-thru Uncoated

- Weight belt webbing laces thru the weight
- Hardened with antimony to prevent deforming
- Rounded and contoured for comfort
- Great for use with nylon or rubber weight belts
- Ideal for use in weight-integrated BC's
- Full case quantities only

One pound weight pricing includes a \$0.25 per lb surcharge



Lace-thru Coated

- Protects boat decks and swimming pools
- Prevents lead from touching your hands
- Black matte finish resists scratching and fading
- Great for use with nylon or rubber weight belts
- Ideal for use in weight-integrated BC's
- Full case quantities only

One pound weight pricing includes a \$0.50 per lb surcharge



Part #	Size	Case Quantity	Case Weight
CL1-BK-30	1 lb	30 units	30 lbs
CL2-BK-20	2 lbs	20 units	40 lbs
CL3-BK-13	3 lbs	13 units	39 lbs
CL4-BK-10	4 lbs	10 units	40 lbs
CL5-BK-8	5 lbs	8 units	40 lbs

Quick-Attach Weights

- 2 pound bullet weight
- Molded with a quick-attach brass clip
- Colorful, long lasting vinyl coating



Part #	Color	Description	Retail
QA2-BK	Black	2 Pound Quick-Attach Weights	25.00
QA2-YL	Yellow		

Weight Pouches (Hook-and-Loop Opening)

- Fill your own pouches
- Opening at top for filling
- Double hook-and-loop safety closure
- Shot weight not included

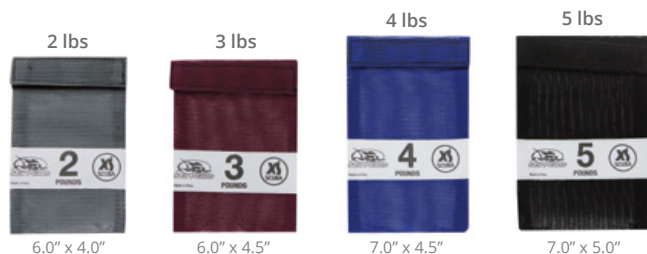

Part #	Color	Designated Weight	Description	Retail
WT02	Gray	2 lbs	Weight Pouches	4.00
WT03	Burgundy	3 lbs		
WT04	Blue	4 lbs		
WT05	Black	5 lbs		

Ankle Weights

- Filled with hardened #5 round shot
- RynoHyde neoprene cover for durability
- Adjustable nylon strap
- High quality quick-release Nexus buckles
- Perfect for adjusting your trim
- Sold in pairs



Part #	Weight (Sold in pairs)	Description	Retail
WA10	1 lb	Ankle Weights	29.50
WA15	1.5 lbs		33.50
WA20	2 lbs		38.00

Bulk Nylon Webbing

- High-grade 2 in (50 mm) Nylon webbing
- Manufactured specifically for diving weight belts
- Resin reinforced for increased stiffness
- Heavy 0.100 in (2.5 mm) thickness
- May not be one continuous length

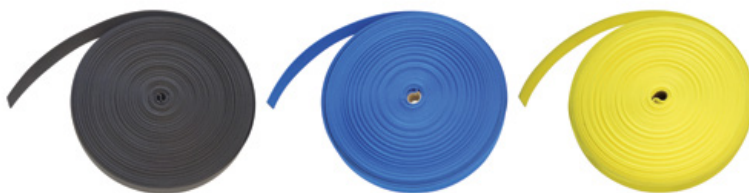

Part #	Color	Description
NW50-BK	Black	50 Yard Roll Nylon Webbing
NW50-BU	Blue	
NW50-YL	Yellow	

Rubber Weight Belt

- Heavy-duty natural rubber strap
- Depth-compensating from stretch rubber material
- 59 in (150 cm) overall length with a belt width of 1.75 in (4.5 cm)
- 0.16 in (4 mm) thick rubber material
- Stainless steel quick-release cam buckle
- Permanent rivet attachment of buckle



Part #	Description	Retail
WB300	Rubber Weight Belt - Quick Release Buckle	43.00

Marseillaise Rubber Weight Belt

- Heavy-duty natural rubber strap
- Depth-compensating from stretch rubber material
- Marseillaise SS buckle has a tilting check pin for quick-release
- 59 in (150 cm) overall length with a belt width of 1.75 in (4.5 cm)
- 0.16 in (4 mm) thick rubber material
- Three rivets placed close to buckle to prevent buckle from rotating in belt



Part #	Description	Retail
WB350	Marseillaise Rubber Weight Belt	45.00

HIGHLAND *Original* Weight Plates - 2 Pack

Sidemount divers, technical divers, and free divers, this product is for you! Highland Weight Plates are a quick and easy way to add block of lead to a 2 in (50 mm) wide piece of webbing such as a harness or weight belt. This will allow for fine tuning of your weight requirement without having to do any disassembly.

- Includes 2 plates and 4 pieces of green bungee
- Plate is molded from rugged glass-filled nylon for maximum durability
- Recommended for 1, 2, 3 and 4 lb blocks of lead
- Numerous pyramid anchor points bite into the webbing to keep the plate securely in place



Scan QR code to view a quick video about "How to Set Up and Install" Weight Plates

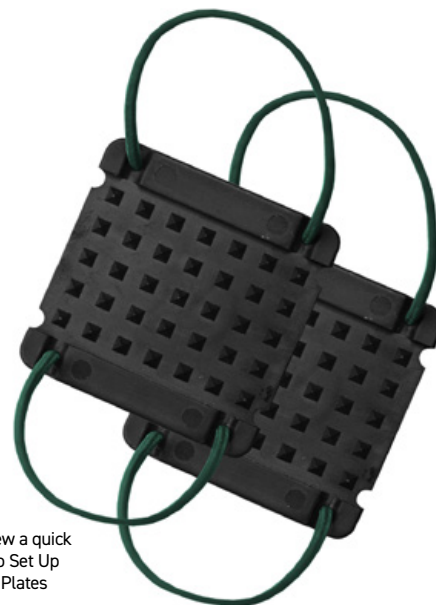

For use with Lace-thru Weights

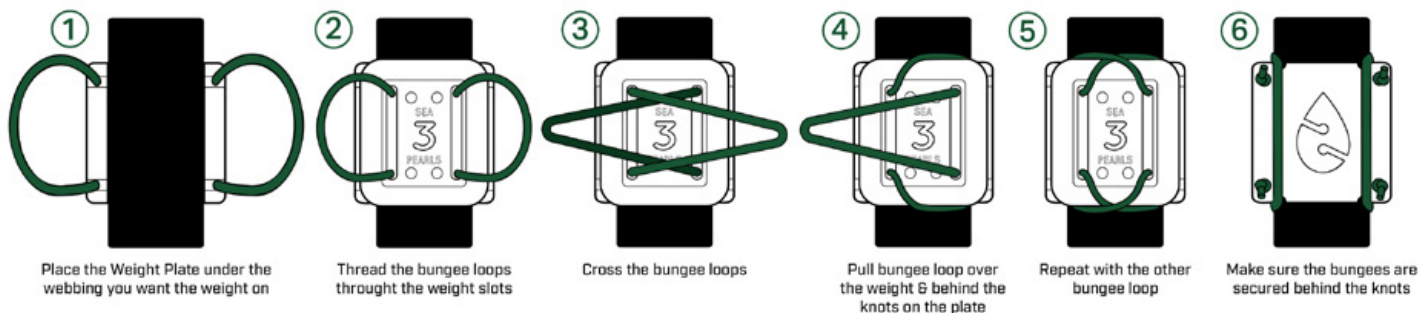

Part #	Description	Retail
HL250	Highland Weight Plates - 2 Pack	27.00

ClearPath Weight Belt

- 60 in (152 cm) high-grade 2 in (50 mm) nylon webbing
- 4 Delrin weight keepers - matching color
- Includes ClearPath weight belt buckle
- Attractive clam-shell packaging

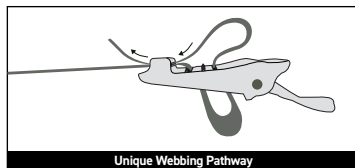

Part #	Color	Description	Retail
WB200-BK	Black	Clearpath Weight Belt with (4) Weight Keepers	28.00
WB200-BU	Blue		
WB200-YL	Yellow		

ClearPath Belt Buckle

- Innovative webbing pathway design
- Webbing end runs back under buckle to secure loose webbing
- Molded from glass-filled nylon with 316 SS hinge pin
- Easy use with open webbing channel
- Secure webbing grip with high lift lever
- Fits 2 in (50 mm) webbing



High lift, positive-locking lever.



Wide open, easy to insert webbing.



316 grade SS hinge pin.

Part #	Description	Retail
AC311	ClearPath Belt Buckle	14.00

Standard Weight Belt

- 60" long high-grade 2" wide nylon webbing
- Buckle made from strong, Delrin material



Part #	Color	Description	Retail
WB60-BK	Black	Standard Weight Belt	13.00
WB60-BU	Blue		
WB60-YL	Yellow		
WB60-BK-BULK	Black	Standard Weight Belt (15 Pack)	-
WB60-BU-BULK	Blue		
WB60-YL-BULK	Yellow		

Zippered Pocket Weight Belt

- Built rental tough with 1000D Cordura®
- Each pocket is designed to hold up to 5 lbs (2.25 kg) of hard or soft weight
- Stainless steel grommet for drainage at the base of each pocket
- #10 YKK zippered opening at top
- Sea Pearls original design
- Includes ClearPath weight belt buckle



Part #	Color	Pockets	Max Weight	Waist Size	Retail
WBZ4-BK	Black	4	20 lbs	26 - 53 in	33.00
WBZ4-BU	Blue				
WBZ5-BK	Black	5	25 lbs	31 - 53 in	35.00
WBZ5-BU	Blue				
WBZ6-BK	Black	6	30 lbs	37 - 53 in	37.00
WBZ6-BU	Blue				
WBZ7-BK	Black	7	35 lbs	42 - 65 in	39.00

Pocket Weight Belt

- The most popular weight belt sold today
- Unique pocket weight belt design
- Quick and easy adjustment to your size
- Each pocket holds up to 5 lbs of hard or shot lead
- Unused pockets hook-and-loop flat and streamlined
- Four stainless steel weight keepers
- Built rental tough with 1000D Cordura®
- Includes ClearPath weight belt buckle
- U.S. Patent# 6,146,053



Part #	Description	Color	Max Weight	Retail
WB104-BK	Four Pocket Weight Belt Overall length 60 in	Black	20 lbs	60.00
WB104-BU		Blue		
WB106-BK	Six Pocket Weight Belt Overall length 60 in	Black	30 lbs	65.00
WB106-BU		Blue		
WB108-BK	Eight Pocket Weight Belt Overall length 72 in	Black	40 lbs	75.00
WB108-BU		Blue		

Single Weight Pocket

- Designed to add up to 5 lbs (2.25 kg) of bagged shot or hard weight
- Attaches by sliding over the end of 2 in (50 mm) webbing
- Easy addition to tank band, weight belt or other harness systems
- Perfect for adjusting your trim in the water



Part #	Color	Description	Retail
WB101BK	Black	Single Weight Pocket	13.00
WB101BU	Blue		

Single Weight Pocket with Hook-and-Loop Front

- Same design as Single Weight Pocket above, except:
 - Allows excess webbing from tank cam strap to attach to hook-and-loop on front of weight pocket
 - Keeps cam strap webbing secure against cylinder
- Designed to add up to 5 lbs (2.25 kg) of bagged shot or hard weight
- Easy addition to XS Scuba weight belts or other harness systems
- Perfect for adjusting your trim



Hook-and-Loop On The Front

Part #	Description	Retail
WB101V	Hook-and-Loop Front Weight Pocket	15.00

Quick-Attach Single Weight Pocket

- Same design as Single Weight Pocket above, except:
 - Allows pocket to be quickly added without having to slide over the end of webbing
 - Quick attachment with double hook-and-loop closure at bottom of pocket
- Designed to add up to 5 lbs (2.25 kg) of bagged shot or hard weight
- Easy addition to XS Scuba weight belts or other harness systems
- Perfect for adjusting your trim



Part #	Color	Description	Retail
WB101QA-BK	Black	Quick-Attach Weight Pocket	15.00

Quick-Release Single Weight Pocket

- Hook-and-loop release weight dump - pull out, then down
- Designed to add up to 5 lbs (2.25 kg) of bagged shot or hard weight
- Attaches by sliding over the end of any 2 in (50 mm) webbing
- Easy addition to XS Scuba weight belts or other harness systems
- Perfect for adjusting your trim



Part #	Description	Retail
WB101QR	Quick-Release Weight Pocket	18.00



Bottom-Drop Weight Pockets (Pair)

- Full size weight pocket to add lead weights to a diving harness
- Load weights from the top zipper
- Uses the single-pull Catch n' Release™ dump mechanism
- Attaches to 2 in (50 mm) webbing
- Each pocket holds up to 15 lbs (7 kg) of lead weights
- Sold as a pair

Back



Front



Part #	Description	Retail
HL208	Bottom-Drop Weight Pockets (Pair)	117.00



Side-Slide Weight Pockets (Pair)

Side-Slide weight pockets are an easy way to add lead to a 2 in (50 mm) webbed harness, usually associated with a backplate and a wing.

- Large, side-squeeze 2 in (50 mm) buckles on the front of the pocket for easy release of weights
- Adjustment strap with D-ring to cinch down for snug fit
- Each pocket holds up to 12 lbs (5.5 kg) of lead weights
- The dual grommet tail on the back allows for attachment to the backplate. This keeps pouches from sliding forward
- A 30° angled web retainer on the back provides an option to mount the weights at an upward angle, a feature desirable to small waisted divers
- Book screws not included

Front



BPH51 - Replacement pocket

Part #	Description	Retail
HL209	Side-Slide Weight Pockets (Pair)	104.00
BPH51	Inner Replacement Pocket - Black (Single)	30.00



Tail Weight Pouch

- Designed for adjusting your trim when using double cylinders
- Attach with lower cylinder band bolt
- Two stainless steel grommets for attachment
- Sealed opening with double hook-and-loop closure
- Holds up to 6 lbs (2.7 kg) of #5 or smaller lead shot
- Wide opening allows the use of hard weight up to 5 lbs (2.25 kg)



See Page 25



Part #	Description	Retail
WB500	Tail Weight Pouch	18.00
HL510	SS Book Screw - 1 Complete Set	11.00



"V" Weight Pouch

- Add trim weight in the center groove of your backplate
- Attach with twin cylinder band bolts
- Stainless steel grommets
- Two mesh compartments - front and back
- Sealed opening with double hook-and-loop closure
- Holds up to 7 lbs (3.2 kg) of #5 or smaller lead shot

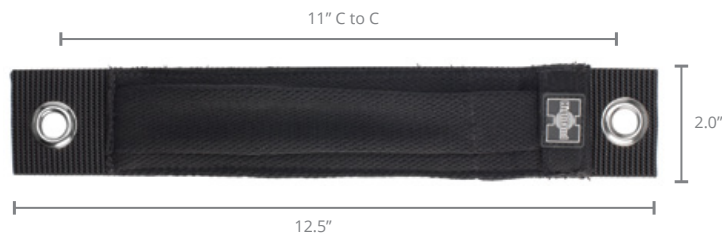

Part #	Description	Retail
WB550	"V" Weight Pouch	20.00
HL510	SS Book Screw - 1 Complete Set	11.00

Stainless Steel Spring-Loaded Buckle

- Replacement for most weight belts
- Adds depth compensation to a weight belt
- Internal springs allow for expansion of buckle
- Rust-free 304 stainless steel
- Fits 2 in (50 mm) webbing



Part #	Description	Retail
AC310	SS Spring-Loaded Weight Buckle	29.00

Weight Belt Buckle - Delrin

- Replacement for most weight belts
- Tough, Delrin material
- Fits 2 in (50 mm) webbing



Part #	Description	Retail
WBB-BK	Delrin Weight Belt Buckle	4.50

Weight Keepers

- Keep your weights positioned where needed
- 3 models to choose from
- 2 in (50 mm) slots, with serrations, for slip-free security



Part #	Description	Color	Retail
WK-BK	Delrin Weight Keeper	Black	1.50
WK-BU		Blue	
WK-YL		Yellow	
WK-SS	SS Weight Keeper	Stainless Steel	2.00
AC305D	SS Keeper with D-ring		10.00

Retainers

- 316 stainless steel



Part #	Description	Retail
HL917	2.0" SS Three Bar Slide	2.00
HL940	SS Rec Ring	5.00
HL941	SS Adjuster (for harness webbing)	4.00

D-Ring Holder [Taco]

Works with HL918

- 316 stainless steel

HL916 with
HL918 Installed

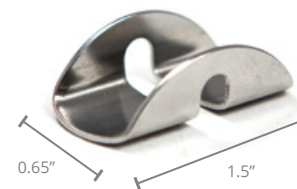

Part #	Description	Retail
HL916	D-Ring Holder (Taco) - Works with HL918 D-ring	3.00



Retainers

- 316 stainless steel



HL942



HL943

Part #	Description	Retail
HL942	T Retainer for 2" Webbing	5.50
HL943	4-Bar Slide w/ Angled D-ring for 2" Webbing	6.50



Billy Rings

- 316 stainless steel

HL908

45°



1.8"

HL909

90°



1.8"

Part #	Description	Retail
HL908	45 Degree Billy Ring	8.00
HL909	90 Degree Billy Ring	



1" Split Rings [5 pack]

Split rings, like tie wraps, are a diver's best friend. Use them to attach items to your D-rings, such as car keys, lanyards and retractors. Keep some in your save-a-dive kit. They're inexpensive but oh so useful.

- 304 stainless steel



Part #	Description	Retail
HL948	1" Split Ring (5 pack)	6.50



Tear Drop Split Rings [5 pack]

These heavy-duty split rings have a nice oval, tear drop shape.

- 1.5 in (38 mm) long x 1 in (25 mm) wide
- 304 stainless steel



Part #	Description	Retail
HL949	Tear Drop Split Rings (5 pack)	11.50



D-Rings

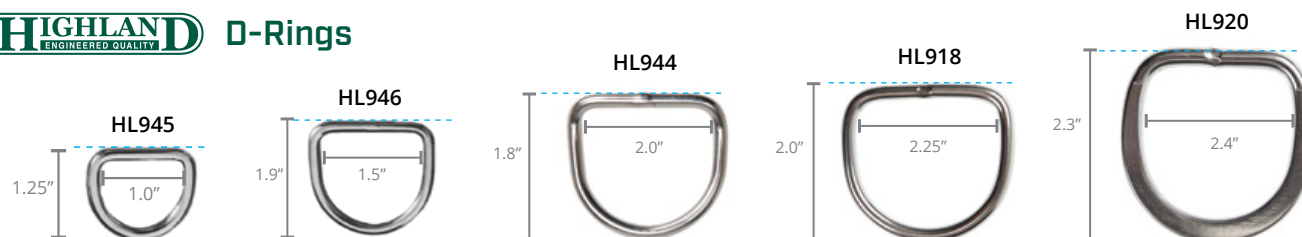

Part #	Description	Retail
HL945	1.0" SS D-Ring 5 mm Wire - 304 Stainless Steel	3.00
HL946	1.5" SS D-Ring 5 mm Wire - 304 Stainless Steel	4.00
HL944	2.0" SS Welded Angled D-Ring 6 mm Wire - 316 Stainless Steel	5.00
HL918	2.0" SS Welded D-Ring 6 mm Wire - 316 Stainless Steel	4.00
HL920	2.0" SS Flat Lifting D-Ring 8 mm Wire - 316 Stainless Steel	9.00



Double-ender Bolt Snaps

Highland Double-ender Bolt Snaps are made of high-quality marine-grade 316 stainless steel. They are highly polished and outfitted with premium stainless steel springs. The result is evident by how smooth the bolt action is.

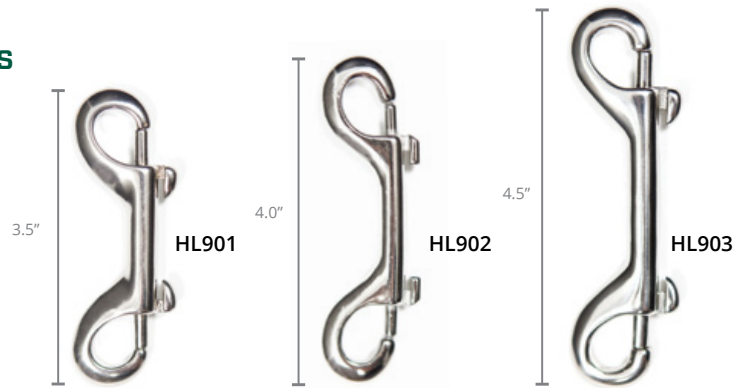

Part #	Description	Retail
HL901	3.5" Double-ender Bolt Snap	10.50
HL902	4.0" Double-ender Bolt Snap	12.50
HL903	4.5" Double-ender Bolt Snap	14.50



Shackle Bolt Snaps

Highland Shackle Bolt Snaps are made of high-quality marine-grade 316 stainless steel. They are unique in that they combine a D-shackle with a bolt snap. They are useful when you want to keep a bolt snap semi-permanently mounted to an accessory item, such as a reel or a DM pointer.

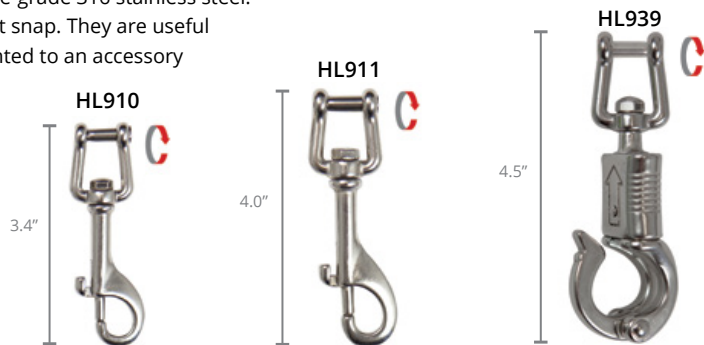

Part #	Description	Retail
HL910	3.4" Shackle Bolt Snap	16.50
HL911	4.0" Shackle Bolt Snap	18.50
HL939	4.5" SS Shackle	10.00



Snap Shackles

- 316 stainless steel, except HL929, which is brass

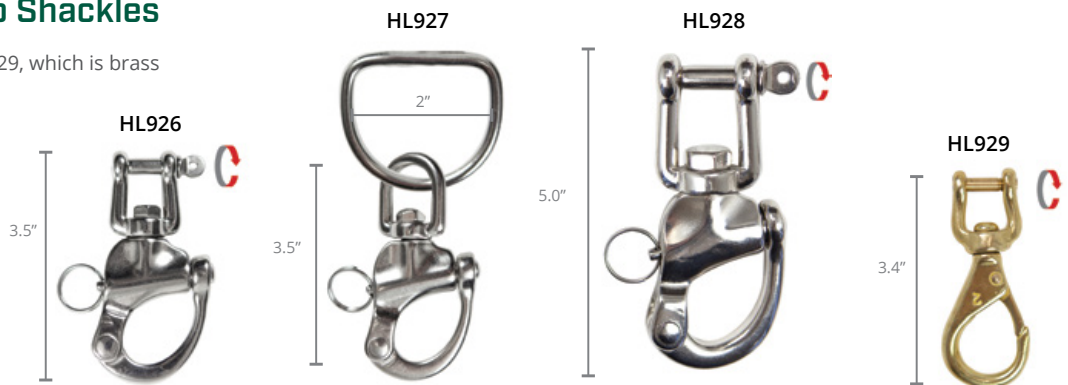

Part #	Description	Retail
HL926	3.5" Snap Shackle	26.00
HL927	3.5" Snap Shackle on 2" Welded D-Ring	21.00
HL928	5.0" Snap Shackle	41.00
HL929	3.4" #2 Brass Shackle Snap Hook	11.00



Swivel Bolt Snaps

- 316 stainless steel



Part #	Description	Retail
HL904	2.75" Swivel Bolt Snap	10.50
HL905	3.5" Swivel Bolt Snap	12.50
HL906	4.75" Swivel Bolt Snap	16.50
HL907	3.75" Butterfly Swivel Bolt Snap	14.50
HL913	4.0" "U" Top Swivel Bolt Snap	14.50
HL915	4.75" Swivel Bolt Snap with 1.75" Ring	20.50



Stainless Steel Spring Hook

While they serve many purposes, Spring Hooks are a strong, secure way to attach accessories to your harness or BC.

- 316 stainless steel



Part #	Description	Retail
HL921	2.4" Spring Hook	5.75
HL922	3.2" Spring Hook	9.50
HL923	4.0" Spring Hook	14.50
HL924	4.7" Spring Hook	20.50



Stainless Steel Quick-Link

When you need something more permanent than a clip, a quick-link is what you want.

- Useful for attaching chain to small anchors
- 316 stainless steel



Part #	Description	Retail
HL931	1.9" Stainless Steel Quick-Link	5.25
HL932	2.3" Stainless Steel Quick-Link	6.25
HL933	2.5" Stainless Steel Quick-Link	7.00
HL934	3.0" Stainless Steel Quick-Link	9.00



Used with permission by info@divethecave.com

HIGHLAND ENGINEERED QUALITY Garvin Hook

The Garvin Hook is an integral part of a Jonline. Use it to hook on to a vertical ascent line.

- 304 stainless steel

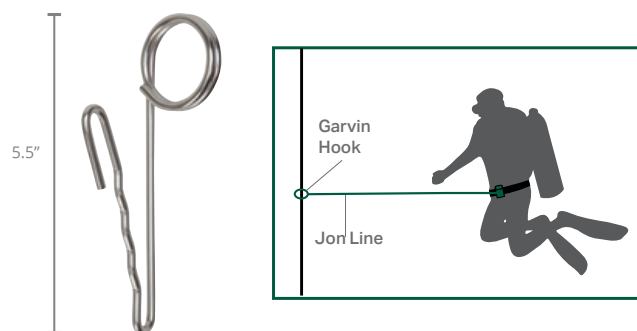

Part #	Description	Retail
HL424	Garvin Hook	9.00

HIGHLAND ENGINEERED QUALITY Deluxe Drop Dee

The Deluxe Drop Dee is a clever, yet versatile, piece of stainless hardware that will enhance any diver's kit. With the ability to reposition the angled D-ring, the plate can be mounted on either horizontal webbing (waist) or vertical webbing (shoulder).

- 316 stainless steel
- D-ring attaches with 2 screws

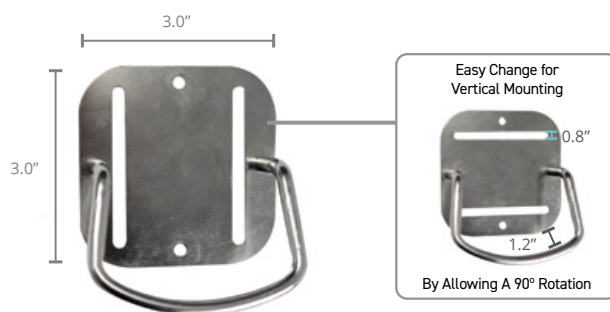

Part #	Description	Retail
HL925	Deluxe Drop Dee - Horizontal or Vertical Mount to 2.0" Webbing	18.00

HIGHLAND ENGINEERED QUALITY 2.0" SS Round Ring

By installing this ring on the neck of your cylinder, you can easily clip off the cylinder for use as a deco hang bottle. You can also place rings on all your cylinders and lock them up by running a cable through them.

- 316 stainless steel



Part #	Description	Retail
HL919	2.0" SS Round Ring	5.25

40% MAX
OXYGEN
PREMIXED

Standard Fill Checker

Attachment to K and PRO valves

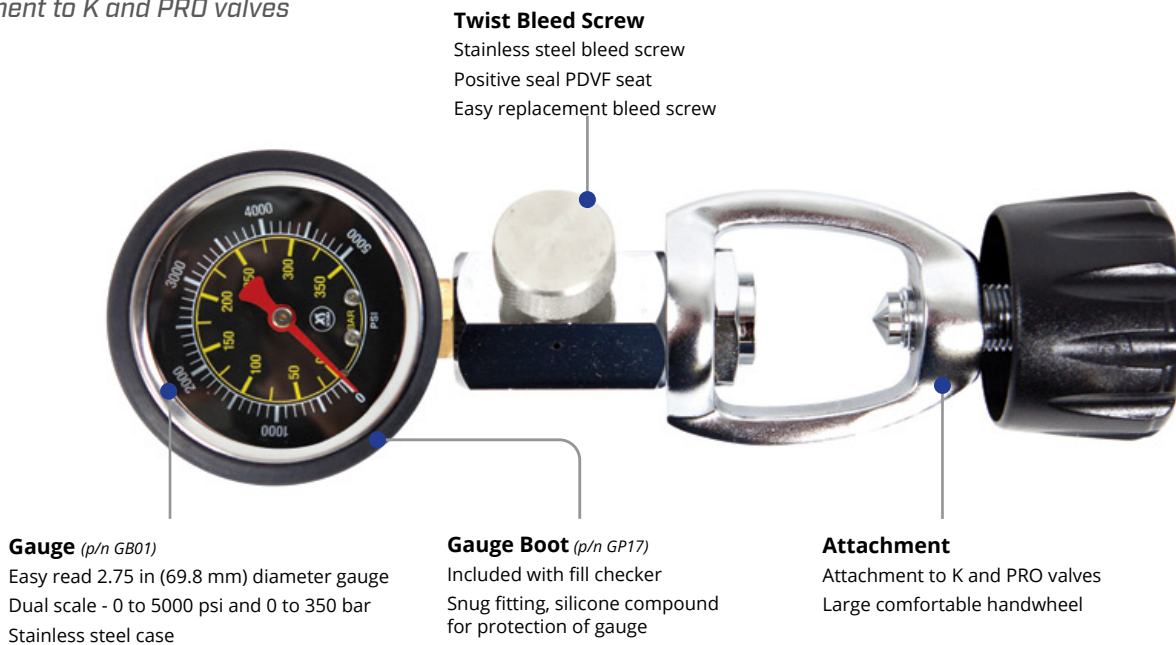

Gauge (p/n GB01)

Easy read 2.75 in (69.8 mm) diameter gauge
Dual scale - 0 to 5000 psi and 0 to 350 bar
Stainless steel case

Twist Bleed Screw

Stainless steel bleed screw
Positive seal PDVF seat
Easy replacement bleed screw

Gauge Boot (p/n GP17)

Included with fill checker
Snug fitting, silicone compound
for protection of gauge

Attachment

Attachment to K and PRO valves
Large comfortable handwheel

Part #	Description	Retail
AC360	Standard Fill Checker	114.00

Deluxe Fill Checker

Attaches to K, PRO and DIN Valves

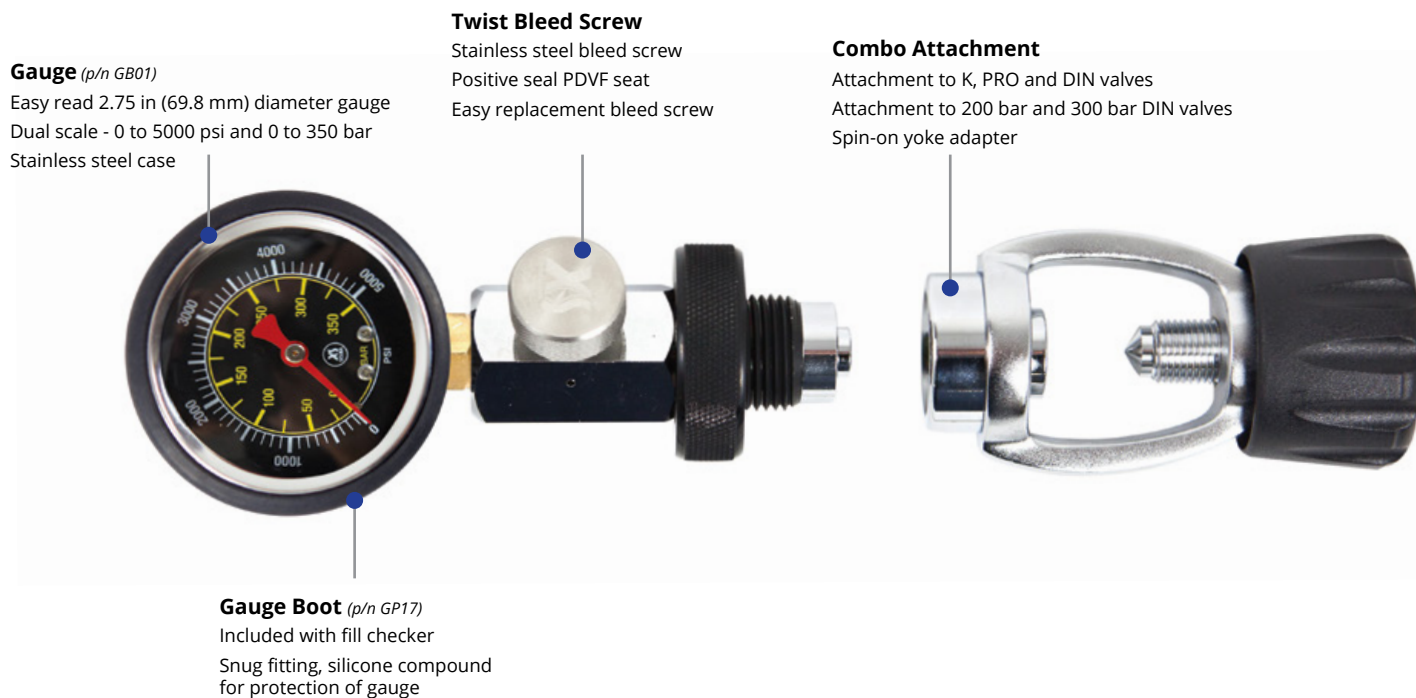
40% MAX
OXYGEN
PREMIXED

Gauge (p/n GB01)

Easy read 2.75 in (69.8 mm) diameter gauge
Dual scale - 0 to 5000 psi and 0 to 350 bar
Stainless steel case

Twist Bleed Screw

Stainless steel bleed screw
Positive seal PDVF seat
Easy replacement bleed screw

Combo Attachment

Attachment to K, PRO and DIN valves
Attachment to 200 bar and 300 bar DIN valves
Spin-on yoke adapter

Gauge Boot (p/n GP17)

Included with fill checker
Snug fitting, silicone compound
for protection of gauge

Part #	Description	Retail
AC365	Deluxe Fill Checker	154.00

Deluxe Cylinder Equalizer with Braided HP Hose

Transfer Gas From One Cylinder to Another

40% MAX
OXYGEN
PREMIXED

Gauge (p/n GB01)

Easy read 2.75 in (69.8 mm) diameter gauge
Dual scale - 0 to 5000 psi and 0 to 350 bar
Stainless steel case



Combo Attachment

Attaches to K, PRO and
DIN valves
Two spin on yoke adapters



Gauge Boot (p/n GP17)

Included with equalizer
Snug fitting, silicone compound
for protection of gauge

Twist Bleed Screw

Stainless steel bleed screw
Positive seal PDVF seat
Easy replacement bleed screw

Braided HP Hose

Thin
0.32 in (8 mm) Diameter
Length
60 in (152 cm)
p/n BHP60-MM

Part #	Description	Retail
AC366	Deluxe Cylinder Equalizer	260.00
BHP60-MM	60" Braided HP Hose (1/4" NPT Male Fittings Both Ends)	108.00

High Pressure Gauge - Replacement

- Dual scale gauge: 0 to 5000 psi and 0 to 350 bar
- 2.75 in (69.8 mm) diameter
- 1/4" male NPT thread
- Shock resistant housing
- Replacement gauge for AC360, AC365 & AC366
- Gauge boot not included (p/n GP17)
- Above water use only

Not intended for compressor use. Since it is not fluid-filled, the vibration of the compressor will cause the needle to bounce, making it difficult to read.



40% MAX
OXYGEN
PREMIXED

Dimensions:
Front - 67.5 mm
Back - 62 mm
Depth - 30.3 mm

PLEASE NOTE

This is a precision, high-quality gauge. Gauge accuracy is checked at three points at the factory prior to shipping. Over-pressurization, mishandling, impact or extended use can decrease the accuracy of this gauge. This gauge is warranted to be accurate at your time of receipt only.

Part #	Description	Retail
GB01	High Pressure Gauge Only	47.00
GP17	Replacement Gauge Boot Only	11.00

Stainless Steel Bleed Screws

- AC361 has an extended seat to mate with a recessed conic orifice
- AC362 has a flush seat to mate with a raised conic orifice

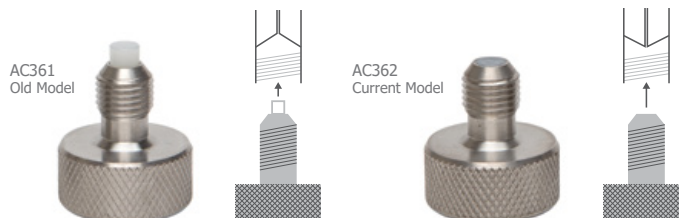

Part #	Description	Retail
AC361	Bleed Screw with Extended Seat	24.00
AC362	Bleed Screw with Flush Seat	

Intermediate Pressure Gauge Checker

Quick and Accurate Check of First Stage Intermediate Pressure

PLEASE NOTE

This is a precision, high-quality gauge. Gauge accuracy is checked at three points at the factory prior to shipping. Over-pressurization, mishandling, impact or extended use can decrease the accuracy of this gauge. This gauge is warranted to be accurate at your time of receipt only.

Push Button Bleeder

Spin-On Adapter
(included) (p/n AC382)

Allows fast attachment to standard BC QD hose



Low Pressure Gauge (p/n GB02)

Dual scale gauge 0 to 300 psi and 0 to 20 bar
2.75 in (69.8 mm) diameter
Stainless steel case
Above water use only

Gauge Boot (p/n GP17)

Included with fill checker
Snug fitting, silicone compound for protection of gauge

Std. Over Pressure Valve (p/n AC395)

Over pressure relief valve set at 175-185 psi
Hidden in picture

LP Port Attachment

Part #	Description
AC380	Intermediate Pressure Gauge Checker with QD Adapter
AC382	Spin-On Adapter 3/8"-24 Female to QD
GB02	Replacement Low Pressure Gauge without Rubber Boot
GP17	Replacement Gauge Boot Only

Regulator Inline Adjuster

0.32 in (8.2 mm)
slotted drive -

5 mm hex drive -

Reversible Low Pressure Gauge

Swap the gauge from left to right side to allow access to both drives
Hand tighten fittings, no wrench needed
One side: 0.32 in (8.2 mm) slotted drive
Other side: 5 mm hex drive

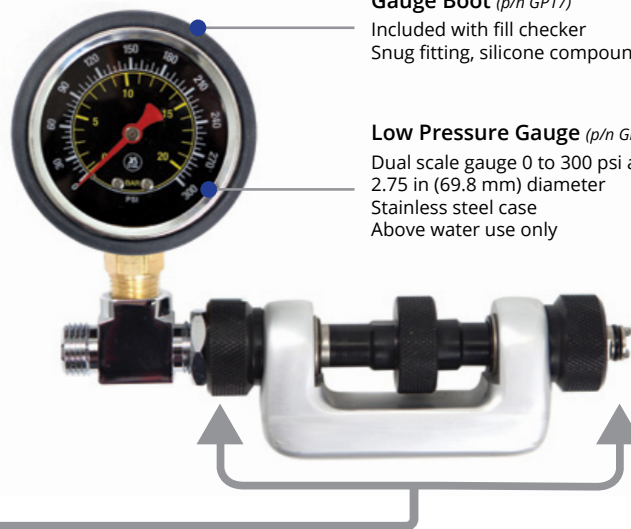

Gauge Boot (p/n GP17)

Included with fill checker
Snug fitting, silicone compound for protection of gauge

Low Pressure Gauge (p/n GB02)

Dual scale gauge 0 to 300 psi and 0 to 20 bar
2.75 in (69.8 mm) diameter
Stainless steel case
Above water use only

Part #	Description
TL121	Regulator Inline Adjuster
GB02	Replacement Low Pressure Gauge without Rubber Boot
GP17	Replacement Gauge Boot Only
RP200-19	Replacement O-ring

Combo Filler

- Recommended for a save-a-dive kit
- Easy attachment to standard BC quick-disconnect hose
- One end is a standard tire filler
- Other end is a nozzle for blowing air
- Low pressure only - below 200 psi



Overall Length
3.7 in (9 cm)

Part #	Description	Retail
AC975	Combo Filler - Air Nozzle & Tire Filler	40.00

BC Washout Hose

- Fits hose mount inflators and also bladder mounted inflators with standard male QD nipple
- Fill about half way with fresh water to fully rinse inside
- Give the BC a good shaking
- Invert the BC, drain the water and debris out by depressing the oral inflator button
- Inflate and allow to dry before storing
- Wash the inside of your BC often

Wash the inside of your buoyancy compensator to remove the build up of salt crystals and foreign deposits

**NOT COMPATIBLE
WITH BREATHABLE
INFLATORS**



Part #	Description	Retail
TL112	BC Washout Hose	35.00



Inflator Tool

- Perfect field service tool
- Service for Highland Inflator (p/n HL205)
- Internal spanner for power inflator button
- Stainless steel construction



Part #	Description	Retail
TL126	Highland Inflator Tool	14.50



4 mm Bungee Cord

No need to sell bungee cord by the foot. This small 25 ft (7.6 m) roll is consumer friendly. With so many varied uses, every diver should keep a roll on hand. The 5/32 in (4 mm) diameter is the most popular size.

Common uses include:

- Bungee forearm mounts (e.g. compasses, slates)
- Regulator necklaces
- Squeezing down wings and BC bladders
- SMB / Lift bag retainers



Part #	Description	Retail
HL430	4 mm Bungee Cord - 25 ft roll (7.6 m)	14.50

Scuba Valve Tester

- Fast and easy valve testing
- Designed for in-water testing
- Attach yoke to high pressure source
- 60 in (152 cm) braided HP hose
- Standard 3/4" x 14 NPSM threading to fit most scuba valves



TL119-58



TL119-12



TL119-78

Part #	Description
TL119	Scuba Valve Tester
TL119-58	Test Adapter to Spare Air - 3/4"-14 NPSM Male to 5/8"-18 UNF Female
TL119-12	Test Adapter to Pipe Thread Valves - 3/4"-14 NPSM Male to 1/2" NPT Female
TL119-78	Test Adapter for 7/8"-14 UNF Valves for Small-Neck HP Cylinders

Tank Tool - Aluminum Cylinder

- For aluminum scuba cylinders only
- Two tools in one
- Clean and true threads with 420 stainless steel chaser
- Remove corrosion from O-ring gland
- Replaceable adhesive backed sanding discs
- Includes 10 sets of sanding discs

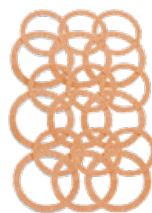

Part #	Description
TL101	Tank Tool with 10 Sets of Sanding Discs
TL102	Replacement Sanding Discs - 10 Sets

LED Visual Inspection Light

The XS Scuba Visual Inspection Light uses the latest LED technology to produce the bright white illumination required to perform a proper visual inspection.

- Bright white - 6000K color temp wavelength
- Wand length is 14 in (36 cm)
- Cord length = 60 in (152 cm)
- 21 LED chips
- Input 100 - 240v 50/60Hz
- Output 12v = 0.7A
- UV additive inhibits fading of the wand
- LED array is mounted on a single-sided, flat ribbon. The light intensity within the cylinder can be adjusted by simply rotating the wand



Part #	Description
TL105	LED Visual Inspection Light

Tank Muffler

- Drain it quietly, drain it slowly, drain it safely
- Attach to DIN or Yoke style valves
- Exhaust holes on opposite side of XS Scuba logo
- All brass construction



Part #	Description	Retail
AC368	Tank Muffler	125.00

Schrader Valve Tool

- Easy removal and installation of schrader valves
- Fits most manufacturer's QD BC hoses



Part #	Description
TL116	Schrader Valve Tool

Valve Handwheel Tool

- Easy removal and installation of valve handwheel nuts
- Fits most manufacturer's valves



Part #	Description
TL113	Valve Handwheel Tool

Multi-Purpose Tool

This very useful tool is a repair technician's best friend.

- Strong 1.5 mm steel wire with flat tip
- Can be used to extract HP seats from pistons or push crown orifices out of 1st & 2nd stage valve bodies



Part #	Description
TL136	Multi-Purpose Tool

Poppet Retainer Tool

This is a very useful tool when servicing standard demand-valve second stages like the XS Scuba Standard Octopus or Hookah second stages. It holds the poppet head stationary so that the locknut can be threaded on to the tail of the poppet.



Part #	Description
TL137	Poppet Retainer Tool

MultiMax Valve Assembly Tool

Considered a "must have" for technicians servicing the MultiMax breathable inflator. It is very helpful during the breathing valve reassembly.



Part #	Description
TL138	MultiMax Valve Assembly Tool

Lubricant Syringes – 2 Ounces

Tribolube-71

- Oxygen safe lubricant compatible with all O-rings and materials used in the scuba industry
- Offers superior anti-wear properties by reducing sticky, residue buildup

Christo-lube MCG 111

- Oxygen-compatible, medium consistency, fluorinated lubricant thickened with PTFE
- Excellent compatibility with metals, plastics and elastomers

Silicone 2080L

- Used widely in the scuba industry in non-oxygen applications
- Light Grade



Part #	Description
TL158	Tribolube-71
TL108	Christo-lube MCG 111
TL159	Silicone 2080L

Silicone Lubricant

- Silicone 2080L lubricant
- Two ounces of lubricant
- Not oxygen compatible



Part #	Description
TL109	Silicone Lubricant 2080L

Workbench Port Plugs

A service technician will use these while testing a rebuilt 1st stage. They are a quick way to plug all the open ports while checking the IP or checking for leaks. No tools required.

- Includes 4 ea. 3/8"-24 LP Plugs & 2 ea. 7/16"-20 HP plugs (6 total)
- Each plug comes with a brown Viton O-ring



Part #	Description
TL139	Workbench Port Plugs

O-Ring Pick Set

- Ideal for O-ring removal without causing damage
- Soft bronze tips - three designs
- Perfect for any diver's save-a-dive kit



Part #	Description	Retail
TL111	O-Ring Picks - Set of 3	26.50

Regulator Support Handle

- Heavy-duty chromed brass construction
- Stainless steel threaded ends
- One end with standard high pressure port threads 7/16"-20 UNF male threads
- The other end with standard low pressure port threads 3/8"-24 UNF male threads
- Ready for vise mounting with flat sides in middle section



Dimensions
6 x 4.25 in
15.25 x 11 cm

Part #	Description
TL122	Regulator Support Handle

Regulator Cover Removal Tool

- Easy removal of second stage front covers
- Silicone material provides excellent grip
- Fits most manufacturer's second stages



Part #	Description
TL117	Regulator Cover Removal Tool

Hose Plugs

Seal Hoses Closed Before Cleaning

- O-ring sealed plugs for both ends of the hose
- Create a watertight seal
- Machined from Delrin
- Never pressurize hose with plugs in place



LP Regulator Hose Set



HP Gauge Hose Set



Inflator Hose Set



The interior of scuba hoses should never be exposed to any type of cleaning solution. Damage can occur from the break-down of the inner lining resulting in the premature failure of the hose. It is the recommendation of XS Scuba that the ends of all scuba hoses be sealed and plugged during servicing to insure that the inner lining is protected from cleaning solutions.

Part #	Description	Retail
TL129	Regulator Hose Plugs	13.50
TL130	High Pressure Gauge Hose Plugs	
TL131	BC Inflator Hose Plugs	

Low Profile - No Barb Mouthpiece Ties

Remove lip irritation with smooth, no-bump tie wraps. The trimmed stub lays flat within the buckle.

- Sold in packs of 100
- Compatible with "Clinch and Trim" guns

Available in 2 sizes

8 in (203 mm) x 0.18 in (4.6 mm)

• Head width 0.34 in (8.6 mm)

• 55 lbs (25 kg) tensile strength

6.75 in (172 mm) x 0.14 in (3.6 mm)

• Head width 0.23 in (5.8 mm)

• 33 lbs (15 kg) tensile strength

• Best choice for regulator mouthpieces and BC airway hoses

Pressure pawl improves grip

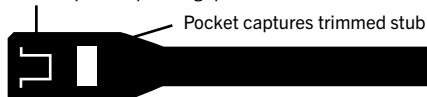

Smooth outer contour

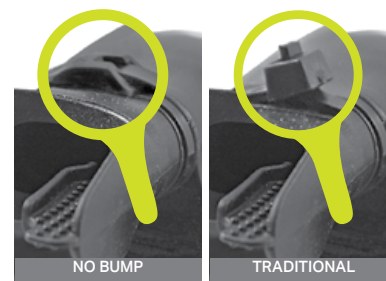
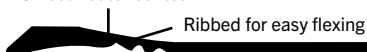

Part #	Description
TL114	No Bump Mouthpiece Ties - 8 in (203 mm) - 100 pieces
TL134	No Bump Mouthpiece Ties - 6.75 in (171 mm) - 100 pieces

Scuba Wrench Set

- Three combination wrench set
- 1/2" by 7/16", 5/8" by 1/2" and 11/16" by 9/16"
- Fit for most common regulator hoses
- Stainless steel construction
- Perfect for any diver's save-a-dive kit



Length
6.0 in (15.25 cm)

Part #	Description	Retail
TL125	Scuba Wrench - Set of 3	24.50

Spanner Wrench - Round Surface

- Most commonly used for the removal and installation of the ambient pressure cap on first stages
- Adjustable range is 0.75" to 2.0" circle diameter
- Three pins included: 0.185", 0.152" and 0.122"
- Fits most manufacturer's first stages



Length
6.5 in (16.5 cm)

Part #	Description
TL118	Spanner Wrench - Round Surface

Spanner Wrench - Flat Surface

- Most commonly used for the removal and installation of the high pressure seat retainer on first stages
- Adjustable range is 0.25" to 2.5" flat surface
- Pin height = 0.15" / Pin diameter 0.07"
- Fits most manufacturer's first stages



Length
4.5 in (11.5 cm)

Part #	Description
TL135	Spanner Wrench - Flat Surface

Yoke Retainer Socket Set

- Accurately torque yoke retaining nuts back to factory specifications
- These sockets are specifically manufactured to fit within the confines of the yoke
- Includes a 1" and a 3/4" socket, both with 3/8" drive
- Includes a 3/8" drive 3" extension with a reduced shank diameter of 0.45"
- Allows use with 1/2" and larger yoke screw holes

Note: Because of the necessary reduction in wall thickness of the sockets exceeding of 50 pounds of torque will result in cracking of the sockets



Part #	Description
TL123	Yoke Retainer Socket Set

Inflator Stem

This barbed, replacement inflator stem can be inserted into the oral tube on snorkeling vests, marker buoys and lift bags. It can be used orally or by connecting a BC LP inflator hose.



Part #	Description	Retail
BP37	Inflator Stem	10.50

Paintball Transfiller

- Allows filling of a paintball cylinder from a scuba cylinder
- Attach to K, PRO and DIN scuba valves



Combo Attachment

Attachment to K, PRO and DIN valves
Attachment to 200 bar and 300 bar DIN valves
Spin-on yoke included



Gauge Port

Standard high pressure port 7/16"-20 UNF
Optional mounting of Pony Gauge (p/n GA050)
Optional mounting of Mini Tech Gauge (p/n HL501)

Twist Bleed Screw

Stainless steel bleed screw
Positive seal PDVF seat
Easy replacement bleed screw

Paintball Connector (p/n AC391)

Stainless steel construction
5000 psi working pressure
Included with Paintball Filler

Part #	Description	Retail
AC390	Paintball Transfiller	155.00

Paintball Connectors

- Stainless steel construction
- 5000 psi working pressure



AC391



AC392



AC393



AC394

Part #	Description	Retail
AC391	Female Paintball to 1/4" Male NPT	49.00
AC392	Female Paintball to 1/4" Female NPT	
AC393	Male Paintball to 1/4" Male NPT	27.00
AC394	Male Paintball to 1/8" Male NPT	

Service Parts



A



B



C



D



E



F



G



H



I

O-ring on underside
fits PRO Valve outlet

Item	Part #	Description	Dimensions/Specs
A	GP10	Air Spool - XS Scuba	Buna-N O-rings
B	HL303	Air Spool - Highland	Viton O-rings
C	BP23	Schrader Valve - Standard	15.3 mm
D	MQD-SV	Schrader Valve - Miflex	15.6 mm
E	AC002	Star Washer	13 mm
F	RP200-06	Wide Cone Filter	18.7 mm x 8.2 mm
G	RP200-32	Low Pressure Port Plug	3/8"-24 UNF Male
H	RP200-16	High Pressure Port Plug	7/16"-20 UNF Male
I	RP200-03	Regulator Dust Cap w/ O-ring	Fits standard yoke inlet



Buoyancy Compensator Size Chart

Model	Size	Height (ft/in)	Height (cm)	Weight (lb)	Weight (kg)	Waist (in)	Waist (cm)	Total Weight Capacity (lb/kg)	Releasable Weight (lbs/kg)	Lift (lbs/N)
Phantom SL	XXS/XS	4'8"-5'5"	142-165	90-125	41-57	26-43	66-109	28/13	20/9	25/110
	SM/MD	5'2"-5'10"	157-178	120-175	55-80	28-45	71-113	28/13	20/9	25/110
	ML/LG	5'10"-6'2"	178-188	165-210	75-96	33-50	84-127	28/13	20/9	35/150
	XL/XXL	6'2"-6'5"	188-193	195-270	89-123	39-56	98-140	28/13	20/9	35/150
Model	Size	Height (ft/in)	Height (cm)	Weight (lb)	Weight (kg)	Waist (in)	Waist (cm)	Total Weight Capacity (lb/kg)	Releasable Weight (lbs/kg)	Lift (lbs/N)
SeaBlazer	XS	5'0"-5'4"	152-160	100-125	46-57	25-37	64-94	20/9	20/9	24/100
	SM	5'2"-5'8"	157-173	120-155	55-71	27-42	69-107	30/13.5	20/9	27/120
	MD	5'7"-5'11"	170-180	150-175	68-80	30-45	75-113	30/13.6	20/9	30/130
	LG	5'10"-6'2"	178-188	175-210	80-96	35-50	89-127	30/13.7	20/9	40/170
	XL	6'1"-6'5"	185-193	195-240	89-109	37-52	94-132	30/13.8	20/9	46/200
Model	Size	Height (ft/in)	Height (cm)	Weight (lb)	Weight (kg)	Waist (in)	Waist (cm)	Total Weight Capacity (lb/kg)	Releasable Weight (lbs/kg)	Lift (lbs/N)
Triton	XS	5'0"-5'4"	152-160	100-125	46-57	25-37	64-94	N/A	N/A	27/120
	SM	5'2"-5'8"	157-173	120-155	55-71	27-42	69-107			30/130
	MD	5'7"-5'11"	170-180	150-175	68-80	30-45	75-113			36/160
	LG	5'10"-6'2"	178-188	175-210	80-96	35-50	89-127			40/170
	XL	6'1"-6'5"	185-193	195-240	89-109	37-52	94-132			46/200
Model	Size	Height (ft/in)	Height (cm)	Weight (lb)	Weight (kg)	Waist (in)	Waist (cm)	Total Weight Capacity (lb/kg)	Releasable Weight (lbs/kg)	Lift (lbs/N)
Companion/ PonyPac	SM	5'0"-5'8"	152-173	80-140	36-64	25-35	64-89	10/4.5	10/4.5	30/130
	RG	5'7"-6'2"	170-188	140-200	64-91	30-50	75-127	10/4.5	10/4.5	30/130
	XL	6'0"-6'5"	183-193	200-260	91-118	45-55	114-140	10/4.5	10/4.5	30/130

Rash Guard Size Chart

Model	Size	(A) Sleeve Length	(B) CHEST CIRCUMFERENCE	(C) Waist CIRCUMFERENCE	(D) Overall Length
Women's Blue Hibiscus Long Sleeve Rash Guard	Small	26" / 65.5 cm	31.5" / 80 cm	28.5" / 72 cm	24.5" / 62 cm
	Medium	26.5" / 67.5 cm	33" / 84 cm	30" / 76 cm	25.5" / 64.5 cm
	Large	27.5" / 69.5 cm	34.5" / 88 cm	31.5" / 80 cm	26" / 66.5 cm
	X-Large	28" / 71.5 cm	36" / 92 cm	33" / 84 cm	27" / 68.5 cm

Model	Size	(A) Sleeve Length	(B) CHEST CIRCUMFERENCE	(C) Waist Circumference	(D) Overall Length
Men's Midnight Harbor Long Sleeve Rash Guard	Medium	27.5" / 70 cm	38" / 97 cm	34" / 86 cm	26" / 66 cm
	Large	28.5" / 72.5 cm	40.5" / 103 cm	36" / 92 cm	27" / 69 cm
	X-Large	29.5" / 75 cm	43" / 109 cm	38.5" / 98 cm	28.5" / 72 cm
	2X-Large	30.5" / 77.5 cm	45.5" / 115 cm	41" / 104 cm	29.5" / 75 cm

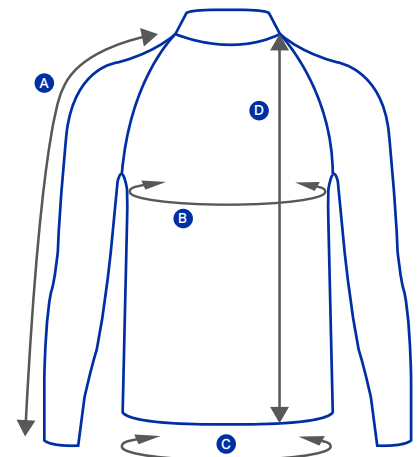

Wetsuit Size Chart

Model	Size	Height	WEIGHT	Chest	Waist	Hips
Men's Wetsuits	Small	5'3" - 5'7" 160 - 170 cm	121 - 154 lbs 55 - 70 kgs	33" - 37" 83 - 94 cm	30" - 34" 76 - 86 cm	34" - 38" 86 - 97 cm
	Medium	5'4" - 5'9" 165 - 175 cm	132 - 176 lbs 60 - 80 kgs	35" - 39" 89 - 99 cm	32" - 35" 81 - 89 cm	36" - 40" 91 - 102 cm
	Large	5'9" - 6'1" 175 - 185 cm	176 - 220 lbs 80 - 100 kgs	37" - 41" 94 - 104 cm	35" - 38" 89 - 97 cm	38" - 42" 97 - 107 cm
	X-Large Short	5'9" - 6'1" 175 - 185 cm	198 - 231 lbs 90 - 105 kgs	41" - 45" 104 - 114 cm	38" - 42" 97 - 107 cm	42" - 46" 107 - 117 cm
	X-Large	5'11" - 6'2" 180 - 188 cm	198 - 231 lbs 90 - 105 kgs	41" - 45" 104 - 114 cm	38" - 42" 97 - 107 cm	42" - 46" 107 - 117 cm
	2X-Large	6'1" - 6'3" 185 - 191 cm	210 - 242 lbs 95 - 110 kgs	43" - 47" 109 - 119 cm	40" - 43" 102 - 109 cm	46" - 48" 117 - 123 cm
	3X-Large	6'3" - 6'5" 191 - 196 cm	242 - 275 lbs 110 - 125 kgs	47" - 49" 119 - 125 cm	42" - 44" 107 - 112 cm	48" - 51" 123 - 130 cm
	4X-Large	6'4" - 6'6" 193 - 198 cm	270 - 295 lbs 122 - 134 kgs	49" - 51" 125 - 130 cm	43" - 45" 109 - 114 cm	51" - 54" 130 - 137 cm

Model	Size	Height	WEIGHT	Chest	Waist	Hips
Women's Wetsuits	X-Small	4'11" - 5'3" 150 - 160 cm	100 - 110 lbs 45 - 50 kgs	29" - 33" 73 - 83 cm	23" - 27" 60 - 70 cm	30" - 34" 76 - 86 cm
	Small	5'1" - 5'5" 155 - 165 cm	110 - 121 lbs 50 - 55 kgs	31" - 35" 78 - 89 cm	25" - 29" 63 - 74 cm	34" - 37" 86 - 94 cm
	Medium	5'3" - 5'7" 160 - 170 cm	121 - 137 lbs 55 - 62 kgs	33" - 37" 84 - 94 cm	27" - 31" 68 - 79 cm	37" - 40" 94 - 102 cm
	Large	5'6" - 5'9" 167 - 177 cm	137 - 157 lbs 62 - 71 kgs	35" - 39" 89 - 99 cm	29" - 33" 74 - 84 cm	40" - 44" 102 - 112 cm
	X-Large	5'7" - 5'11" 172 - 182 cm	157 - 168 lbs 71 - 76 kgs	37" - 41" 94 - 104 cm	31" - 35" 79 - 89 cm	44" - 48" 112 - 123 cm
	2X-Large	5'8" - 6'0"	168 - 180 lbs 76 - 82 kgs	39" - 43" 99 - 109 cm	33" - 43" 84 - 94 cm	48" - 52" 123 - 132 cm
		175 - 185 cm				

Model	Size	Height	Weight	Chest	Waist
3/2mm Shorty Suit	Small	5'3" - 5'8"	135 - 155 lbs	36" - 40"	28" - 31"
	Medium	5'8" - 5'10"	155 - 170 lbs	38" - 40"	31" - 33"
	Large	5'10" - 6'0"	175 - 190 lbs	41" - 42"	33" - 35"
	X-Large	5'11" - 6'3"	190 - 205 lbs	42" - 44"	35" - 37"
	2X-Large	6'0" - 6'3"	205 - 220 lbs	44" - 46"	37" - 39"
	3X-Large	6'1" - 6'4"	230 - 260 lbs	48" - 50"	40" - 43"
	4X-Large	6'1" - 6'6"	280 - 300 lbs	51" - 54"	44" - 47"

Glove Sizing Chart

		XS	SM	MD	LG	XL	2XL
Hand Length	cm	16.9	17.7	18.5	19.3	20.1	20.7
	inches	6.65	6.97	7.28	7.60	7.91	8.15
Palm Circumference	cm	19.5	20.5	21.5	22.5	23.5	24.5
	inches	7.68	8.07	8.46	8.86	9.25	9.65
Wrist Circumference	cm	15.4	16.4	17.4	18.4	19.4	20.4
	inches	6.06	6.46	6.85	7.24	7.64	8.03

(1) Below are illustrations to show the way to measure 3 parts of the hands. (2) If the hands are longer or palms are bigger, they should shift to a larger size.

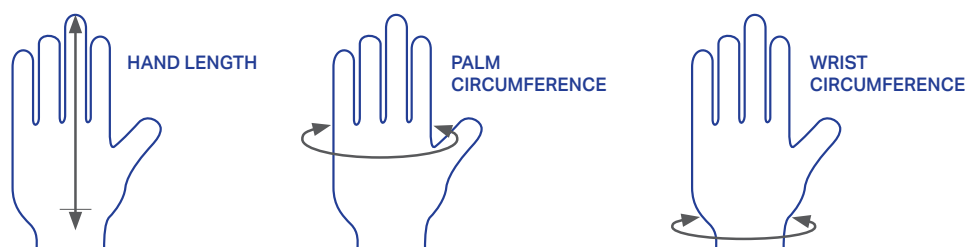



EVERYTHING FOR THE PERFECT DIVE

XS SCUBA, INC.
4040 W. Chandler Avenue
Santa Ana, CA 92704
Tel: 866.977.2822
Local Tel: 714.424.0434
Email: info@XSscuba.com

-  facebook.com/XSscuba
-  [@XSscuba](https://www.instagram.com/XSscuba)
-  [@XSscuba](https://www.youtube.com/XSscuba)

www.XSscuba.com

© Copyright 2024 by XS Scuba, Inc. - All Rights Reserved.